

Quantum spin liquids and the cuprate high temperature superconductors

Indian Institute of Technology
Delhi

January 5, 2024
Subir Sachdev

Maine Christos, Zhu-Xi Luo, Henry Shackleton, Ya-Hui Zhang,
Mathias Scheurer, and S. Sachdev, *Proc. Nat. Acad. Sci.* **120**, e2302701120 (2023)

Alexander Nikolaenko, Jonas v. Milczewski, Darshan G. Joshi,
and S. Sachdev, *Phys. Rev. B* **108**, 045123 (2023)

Maine Christos and S. Sachdev, [arXiv:2308.03835](https://arxiv.org/abs/2308.03835)



PHYSICS



HARVARD



Maine Christos



Zhu-Xi Luo

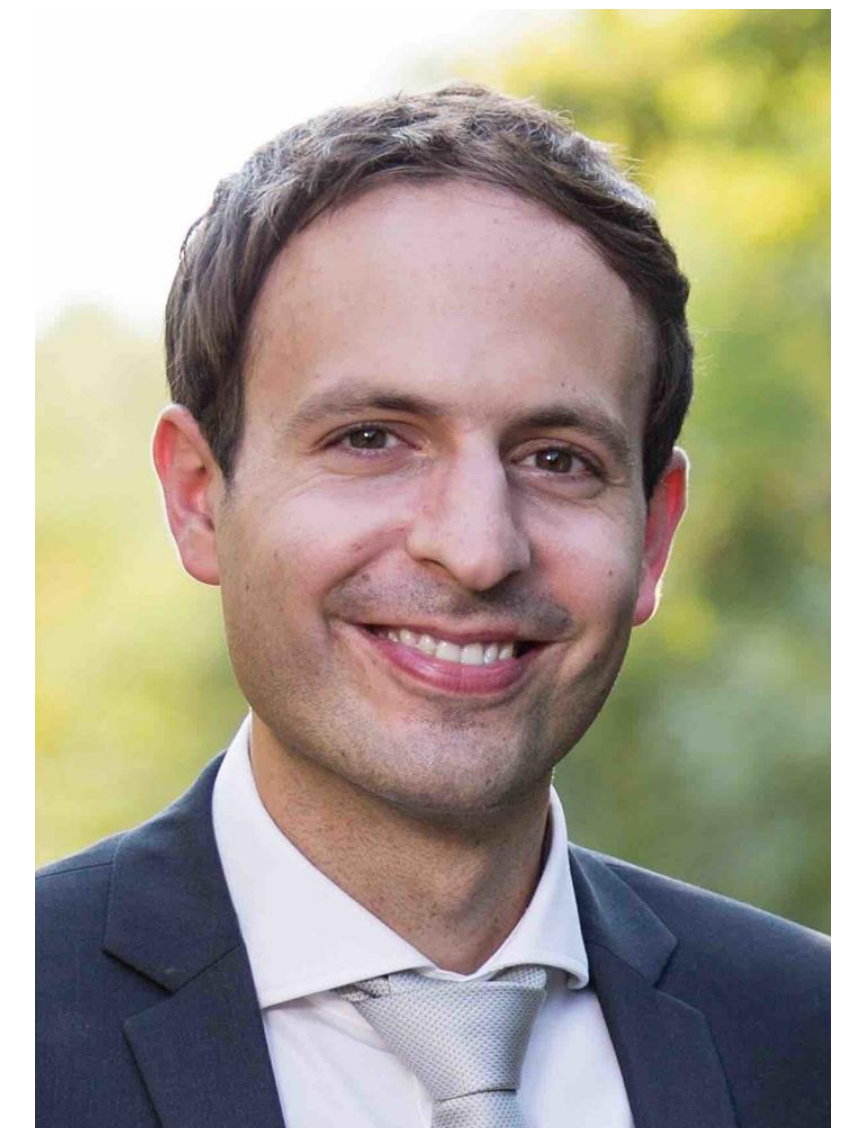

Mathias Scheurer

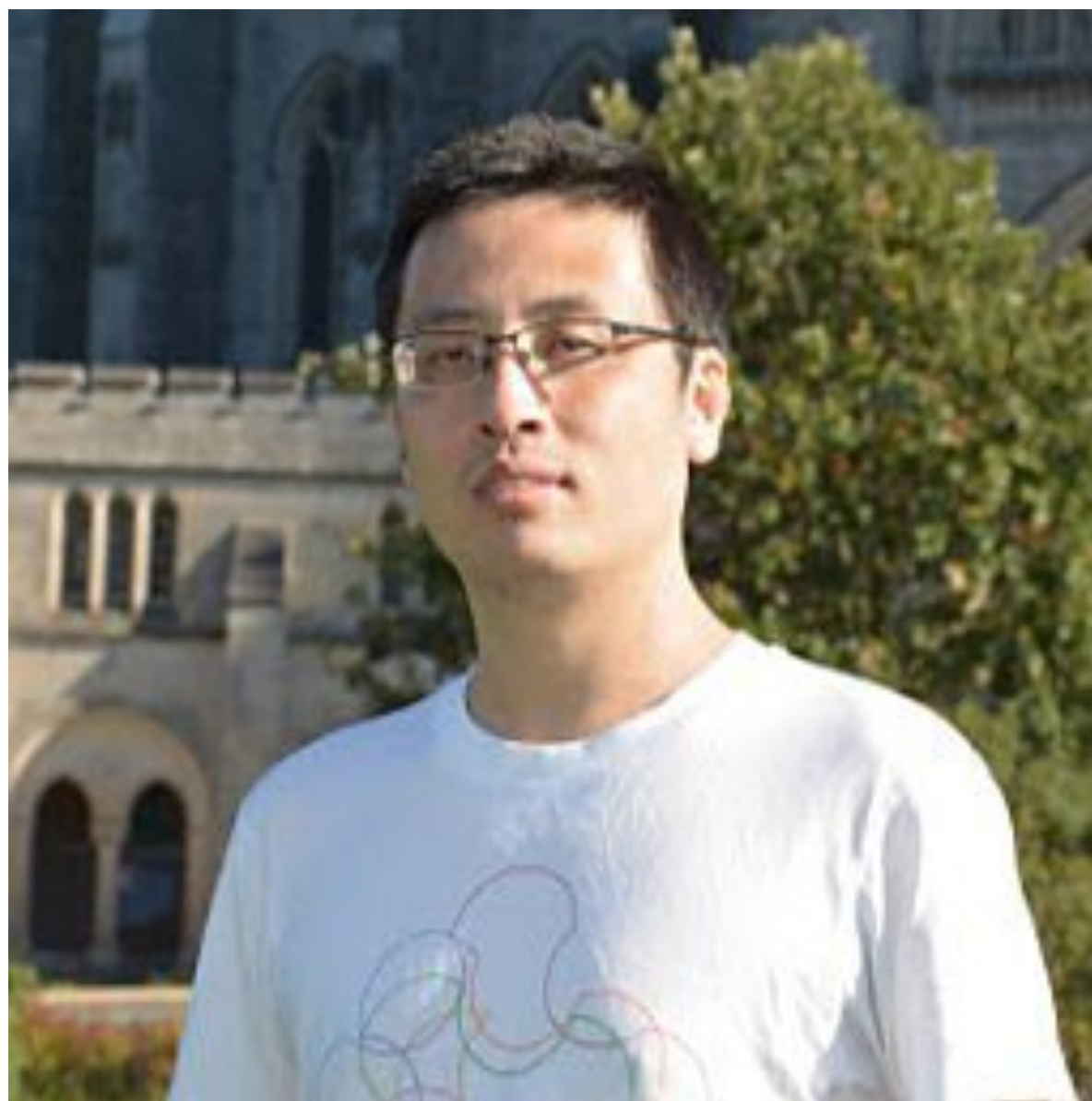

Ya-Hui Zhang



Henry Shackleton

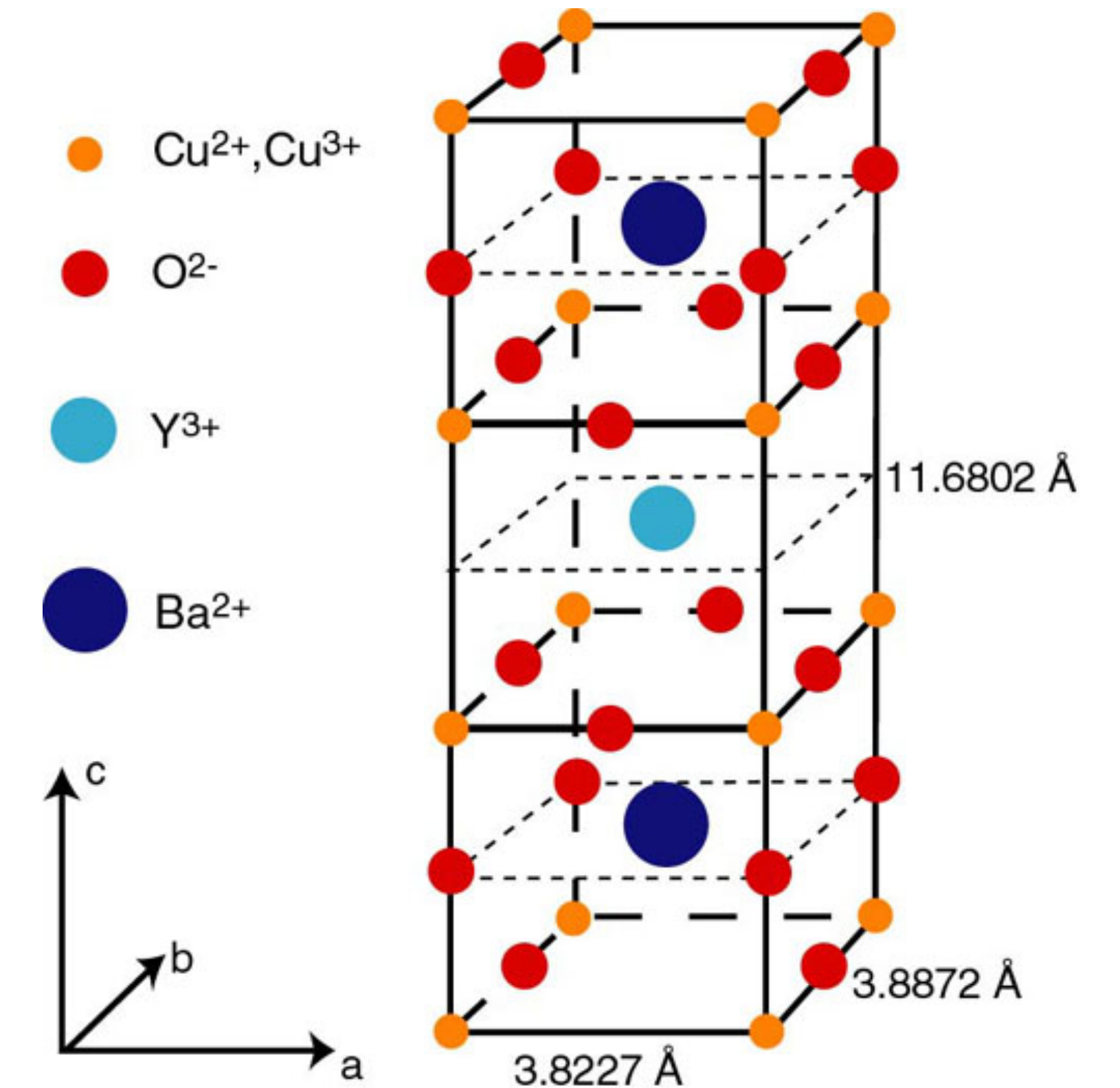
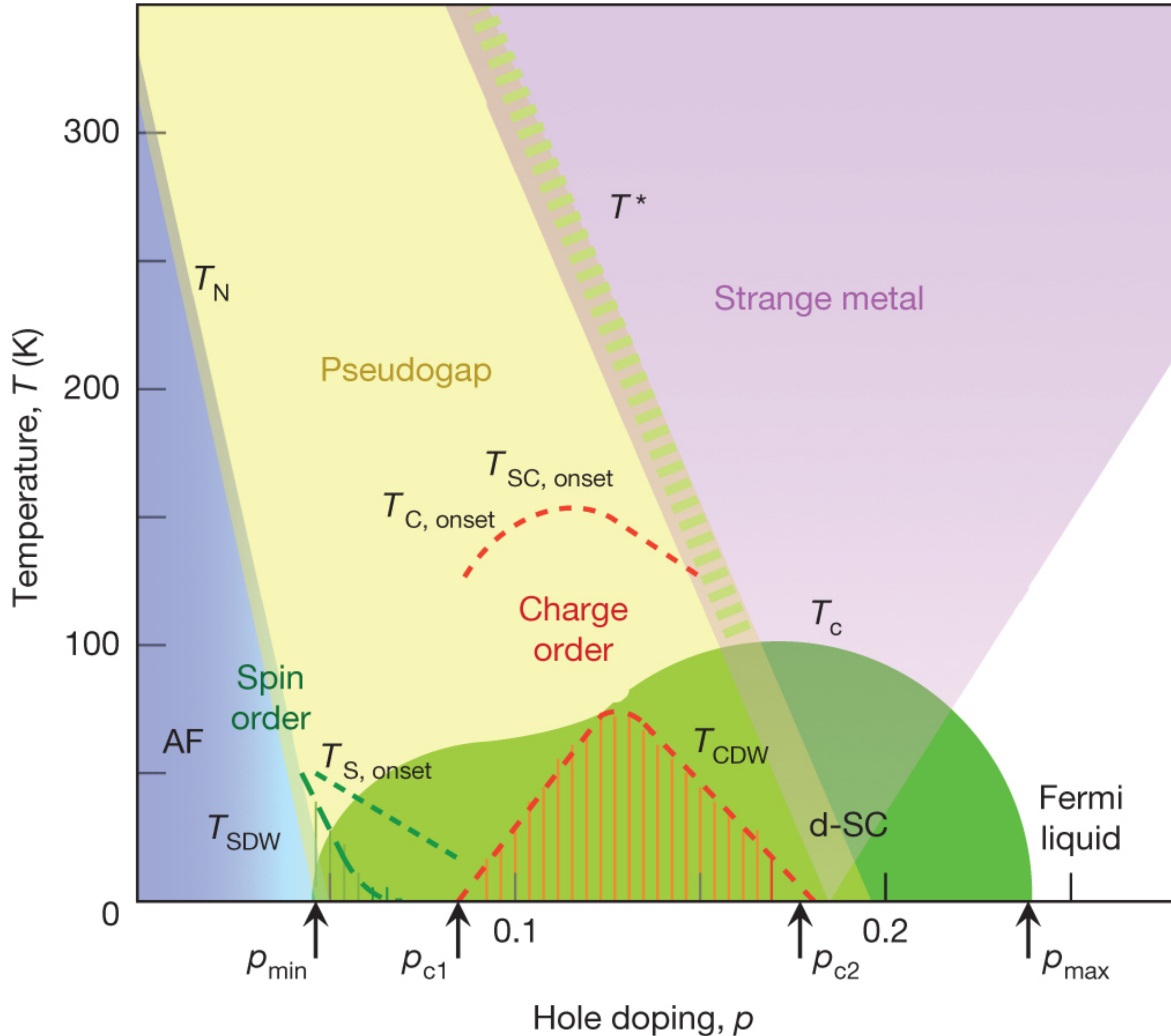

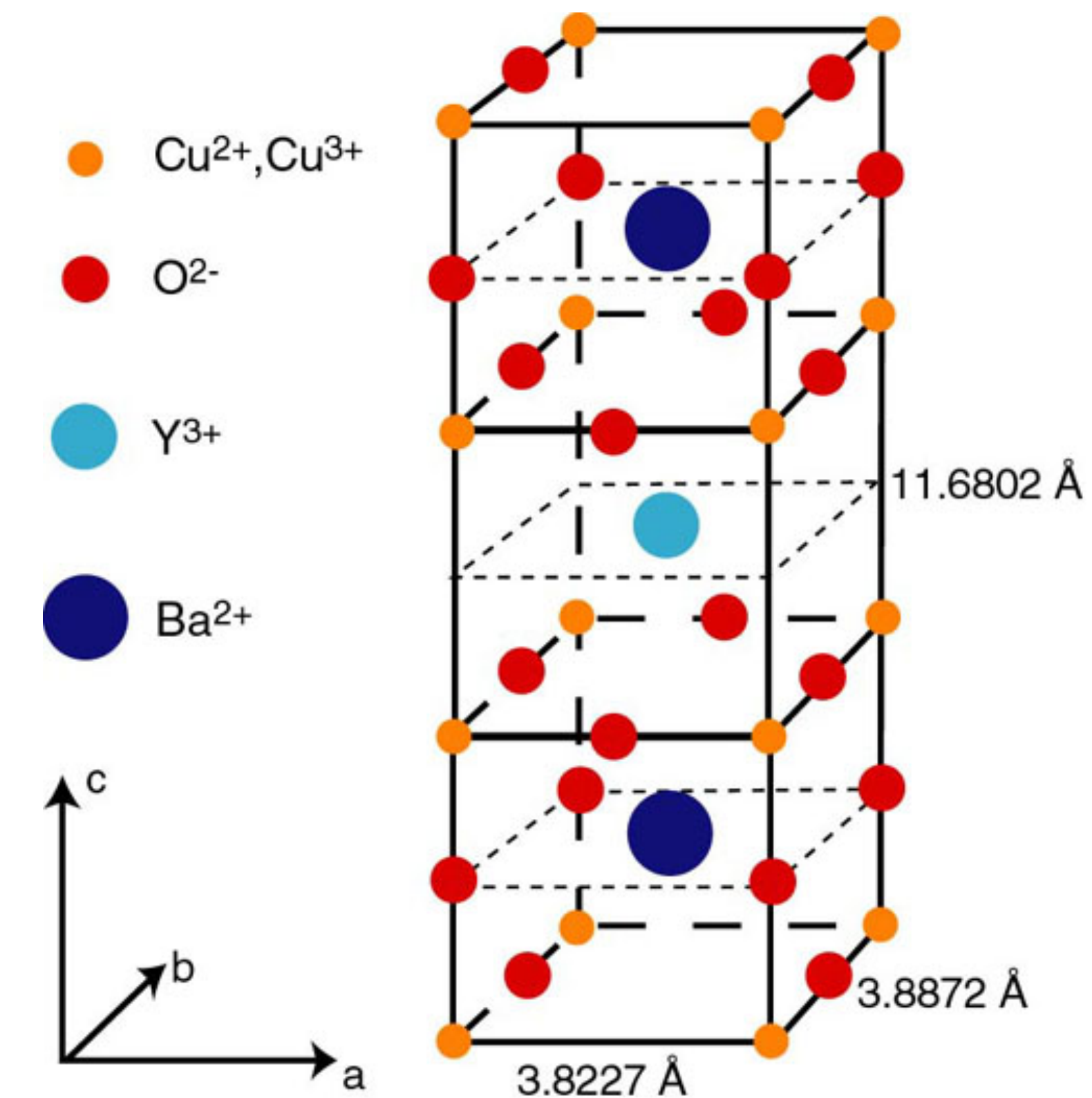
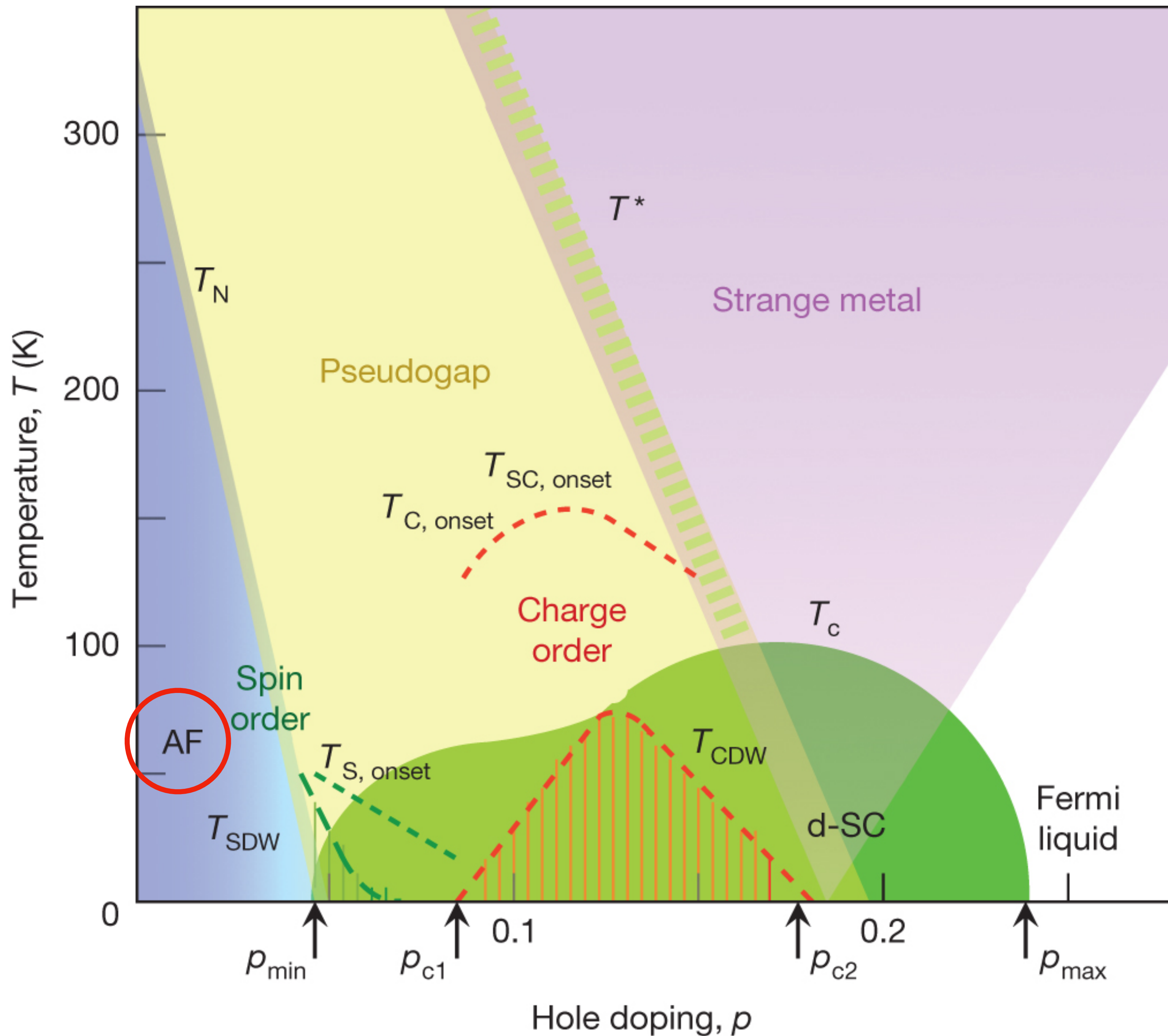

$$\mathcal{H}_H = \sum_{\mathbf{p}} \varepsilon_{\mathbf{p}} c_{\mathbf{p}\sigma}^\dagger c_{\mathbf{p}\sigma} + U \sum_i n_{i\uparrow} n_{i\downarrow}$$

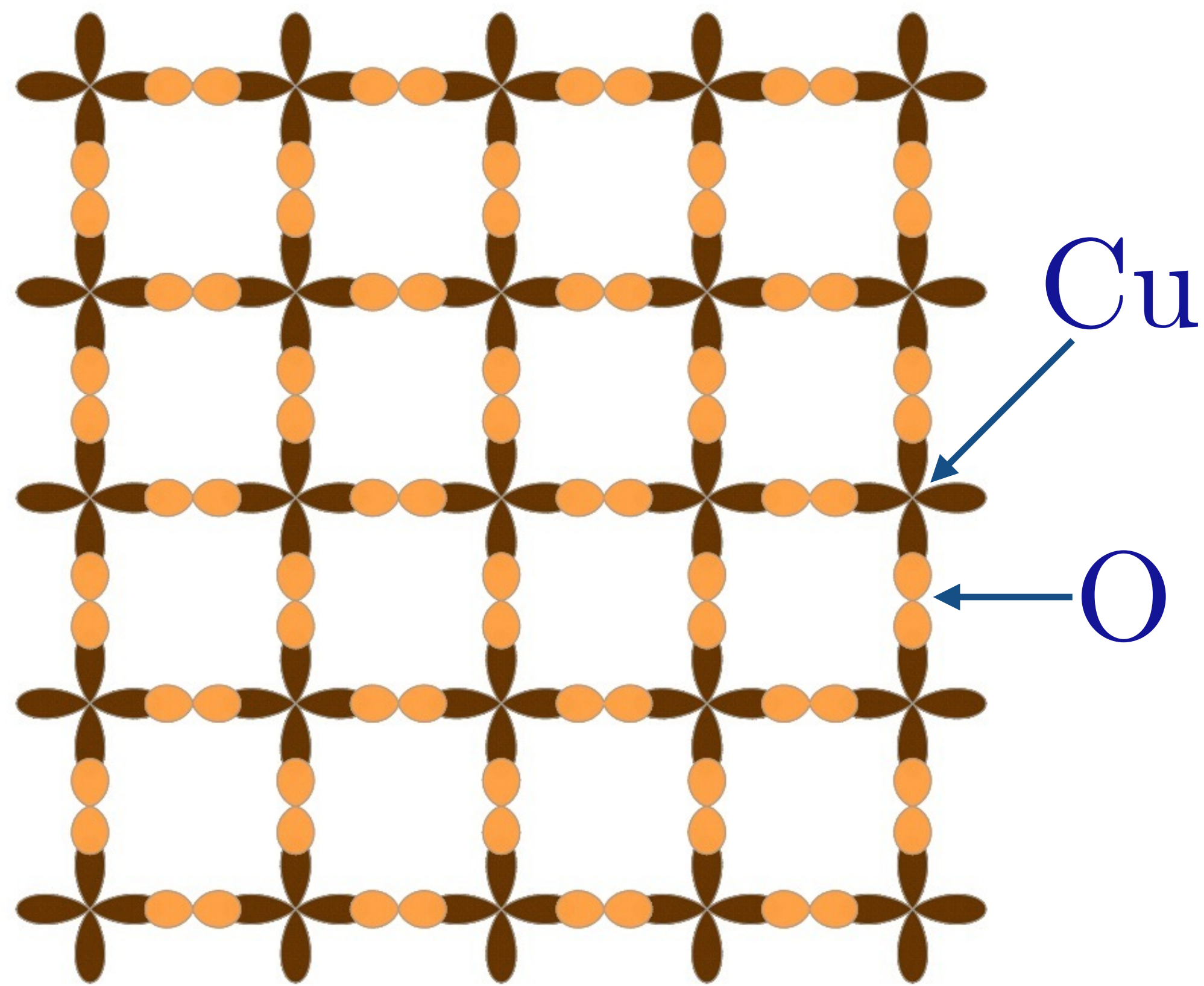

CuO₂ plane

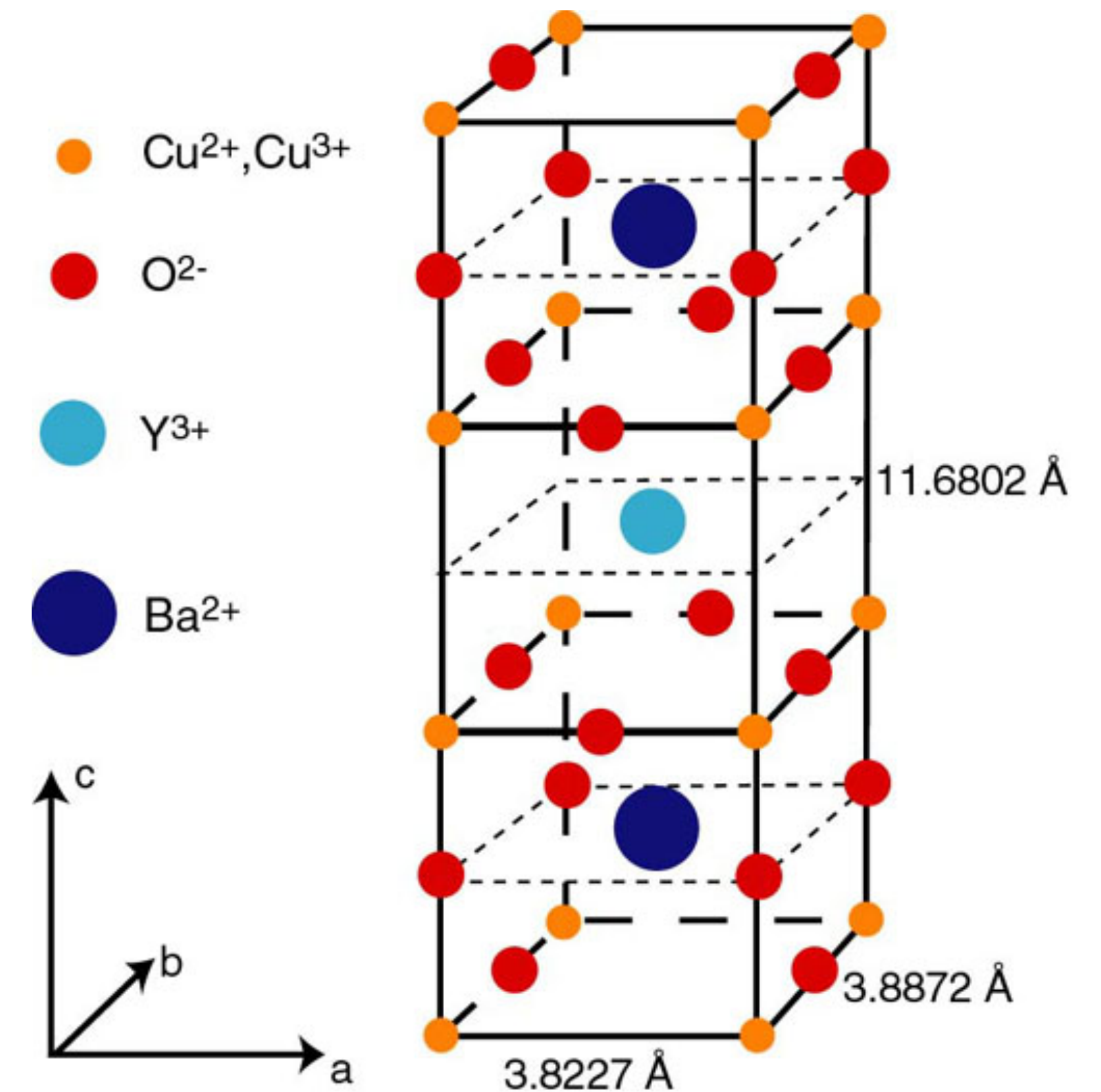

$$\mathcal{H}_H = \sum_{\mathbf{p}} \varepsilon_{\mathbf{p}} c_{\mathbf{p}\sigma}^\dagger c_{\mathbf{p}\sigma} + U \sum_i n_{i\uparrow} n_{i\downarrow}$$

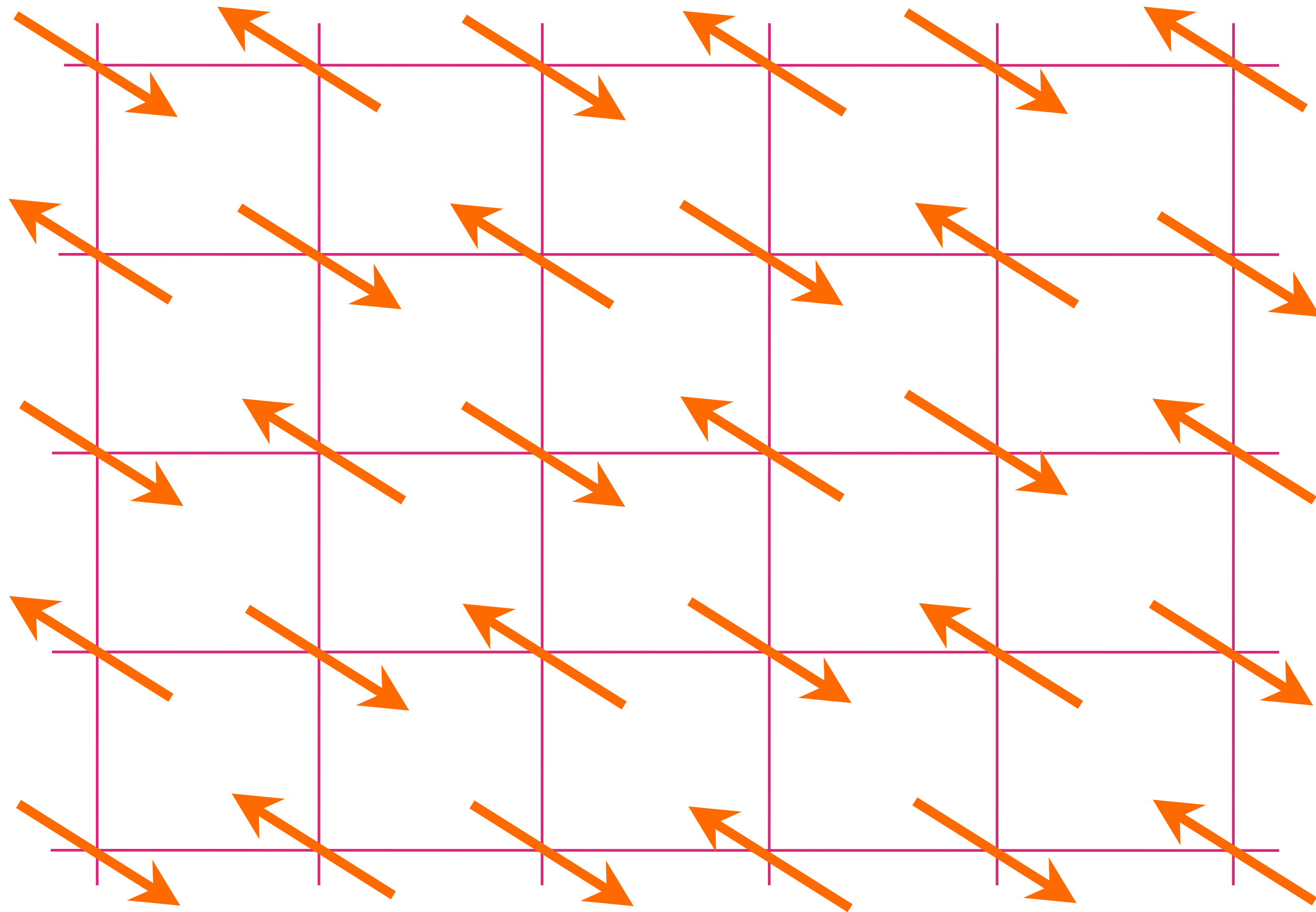

Insulating
antiferromagnet

$$\mathcal{H}_H = \sum_{\mathbf{p}} \varepsilon_{\mathbf{p}} c_{\mathbf{p}\sigma}^\dagger c_{\mathbf{p}\sigma} + U \sum_i n_{i\uparrow} n_{i\downarrow}$$

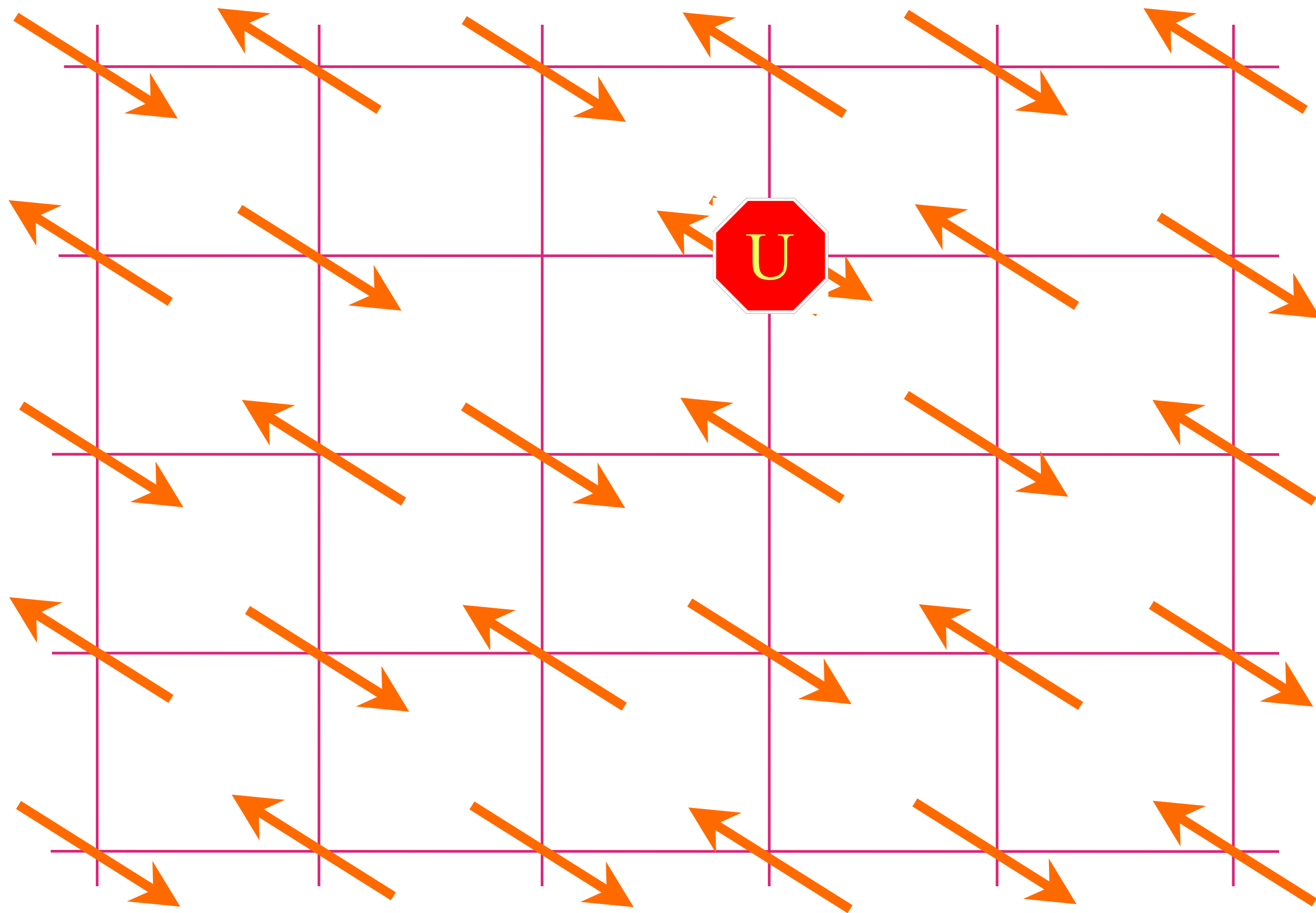

Insulating
antiferromagnet

$$\mathcal{H}_H = \sum_{\mathbf{p}} \varepsilon_{\mathbf{p}} c_{\mathbf{p}\sigma}^\dagger c_{\mathbf{p}\sigma} + U \sum_i n_{i\uparrow} n_{i\downarrow}$$

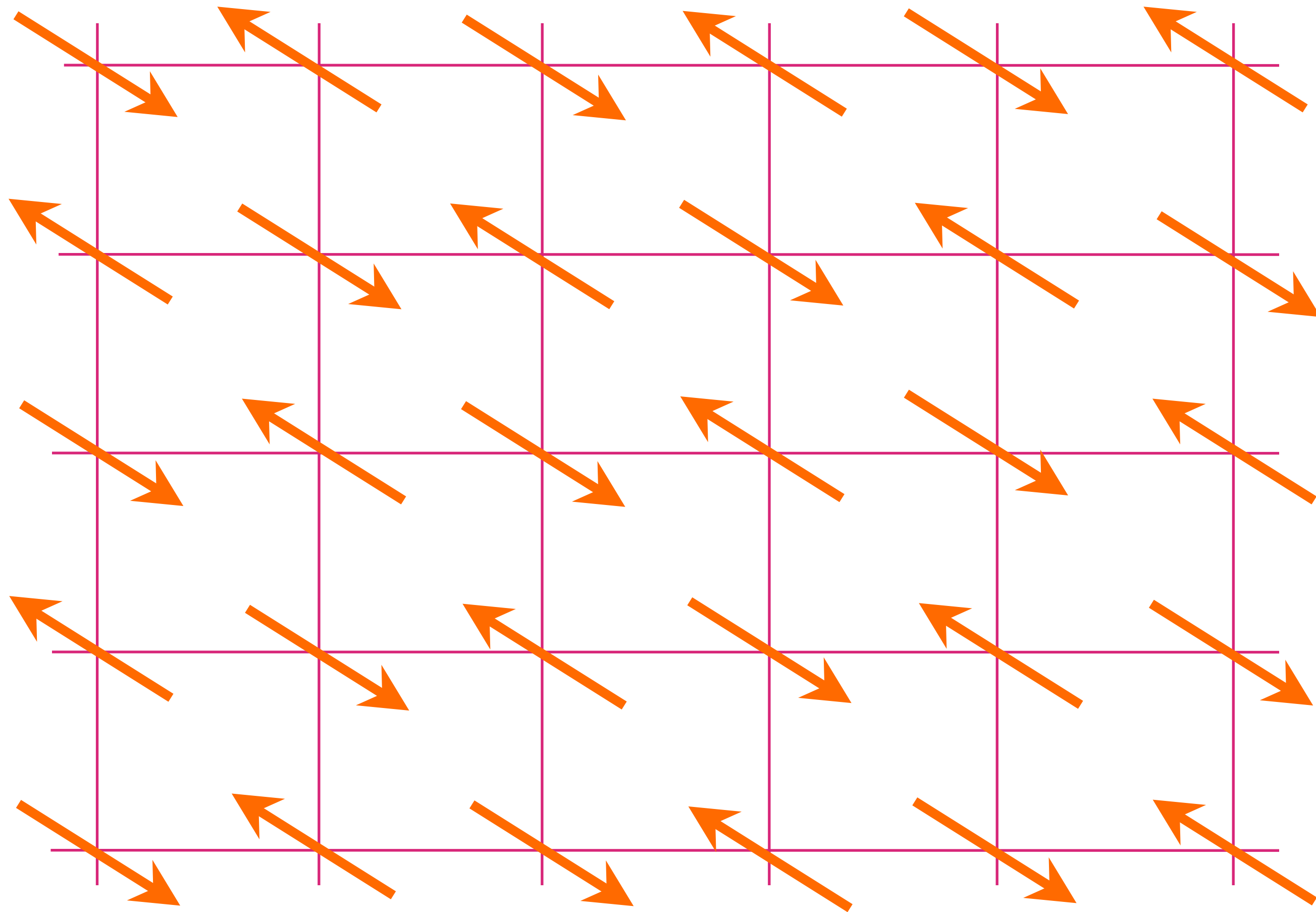

Insulating
antiferromagnet

$$\mathcal{H}_H = \sum_{\mathbf{p}} \varepsilon_{\mathbf{p}} c_{\mathbf{p}\sigma}^\dagger c_{\mathbf{p}\sigma} + U \sum_i n_{i\uparrow} n_{i\downarrow}$$

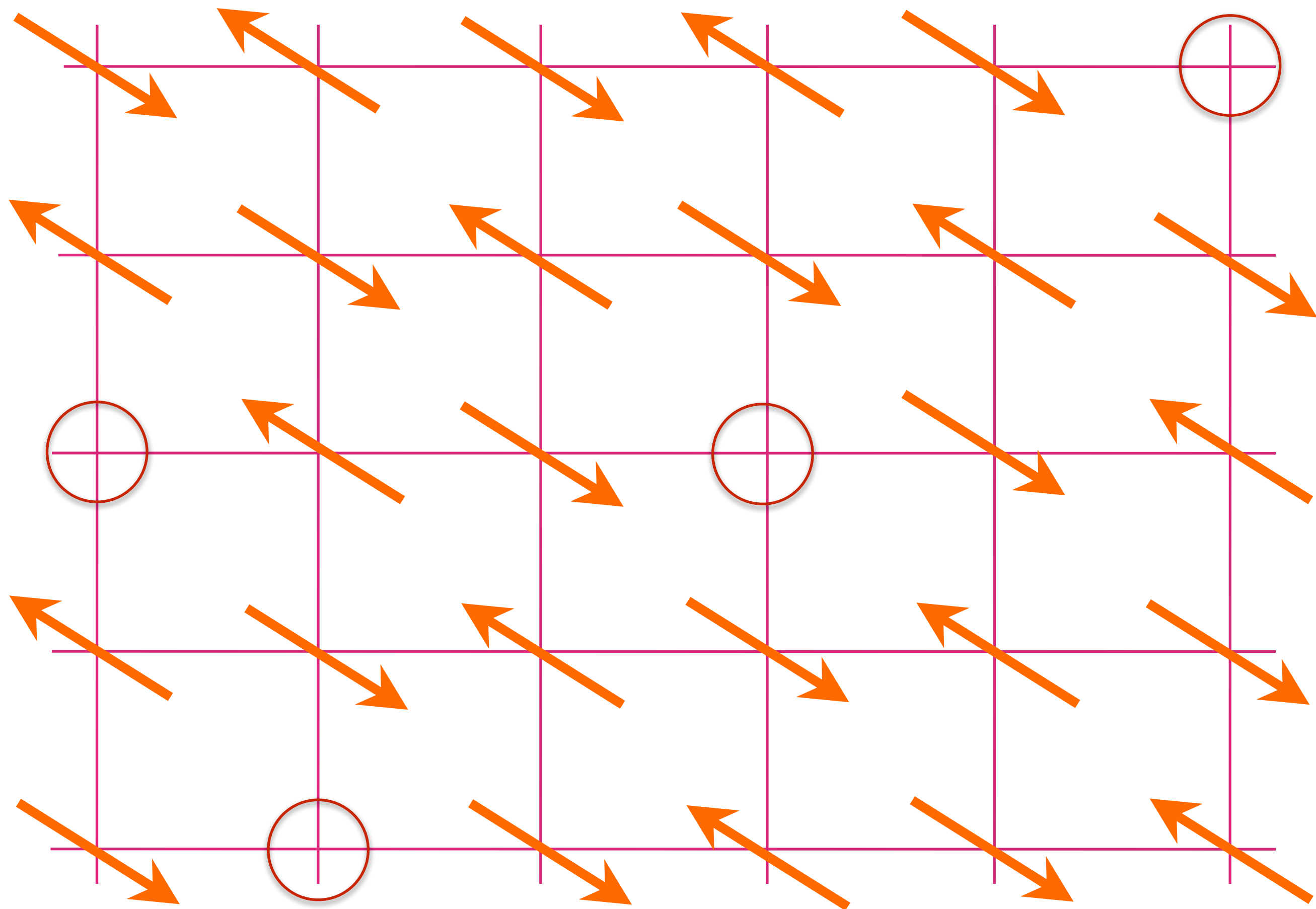

Antiferromagnet
doped with hole
density p

$$\mathcal{H}_H = \sum_{\mathbf{p}} \varepsilon_{\mathbf{p}} c_{\mathbf{p}\sigma}^\dagger c_{\mathbf{p}\sigma} + U \sum_i n_{i\uparrow} n_{i\downarrow}$$

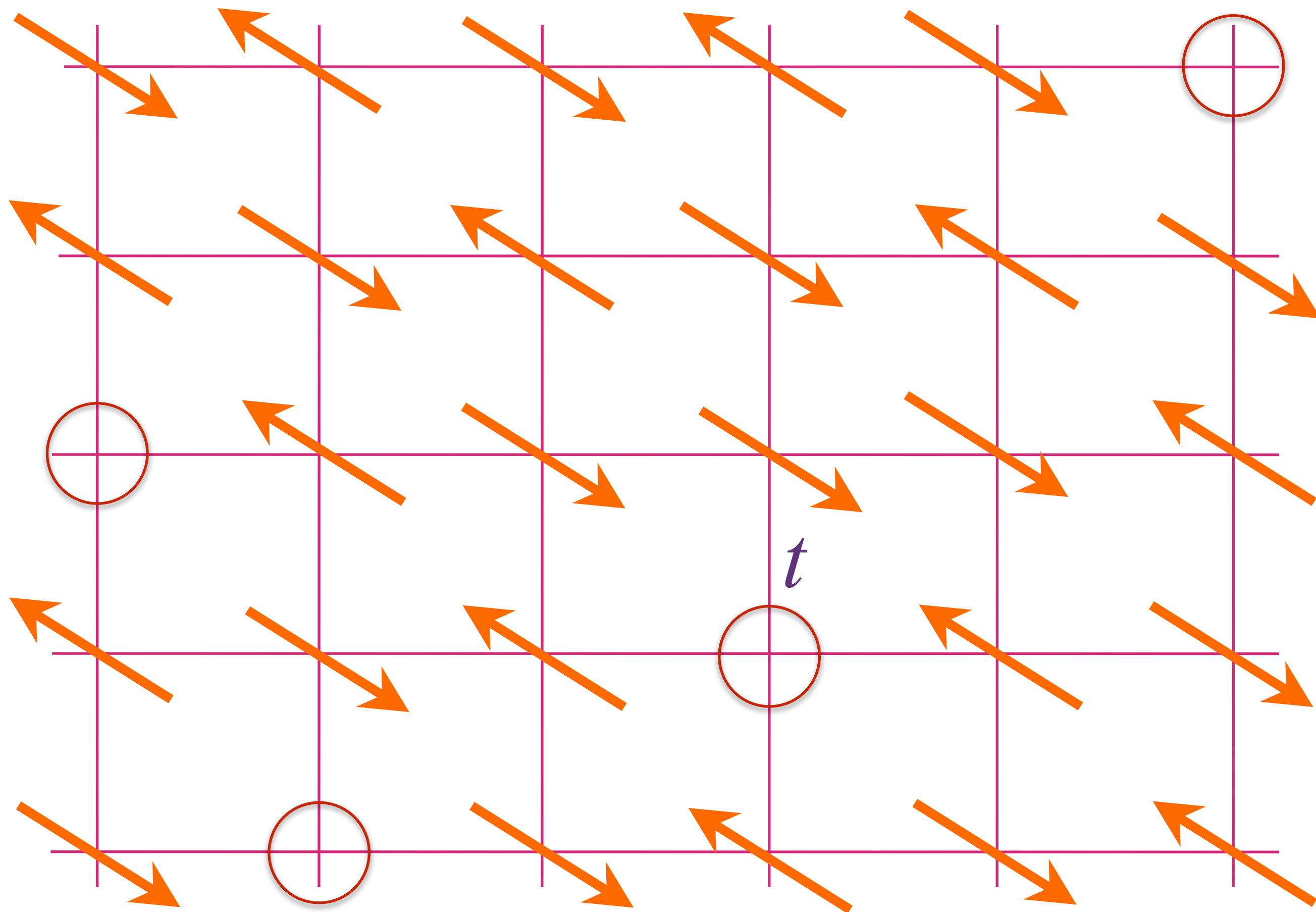

Antiferromagnet
doped with hole
density p

p mobile holes in a
background of
fluctuating spins

$$\mathcal{H}_H = \sum_{\mathbf{p}} \varepsilon_{\mathbf{p}} c_{\mathbf{p}\sigma}^\dagger c_{\mathbf{p}\sigma} + U \sum_i n_{i\uparrow} n_{i\downarrow}$$

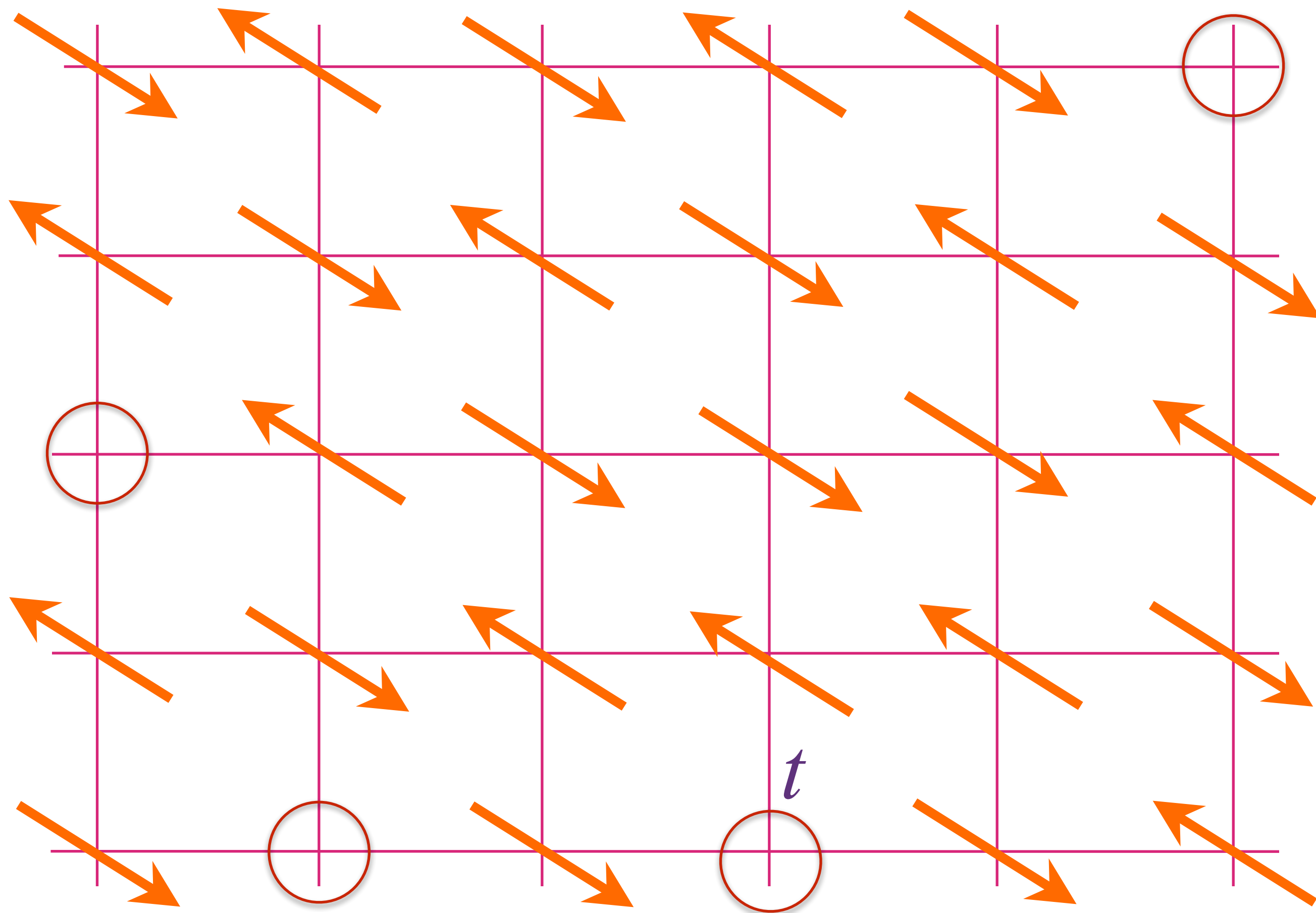

Antiferromagnet
doped with hole
density p

p mobile holes in a
background of
fluctuating spins

$$\mathcal{H}_H = \sum_{\mathbf{p}} \varepsilon_{\mathbf{p}} c_{\mathbf{p}\sigma}^\dagger c_{\mathbf{p}\sigma} + U \sum_i n_{i\uparrow} n_{i\downarrow}$$

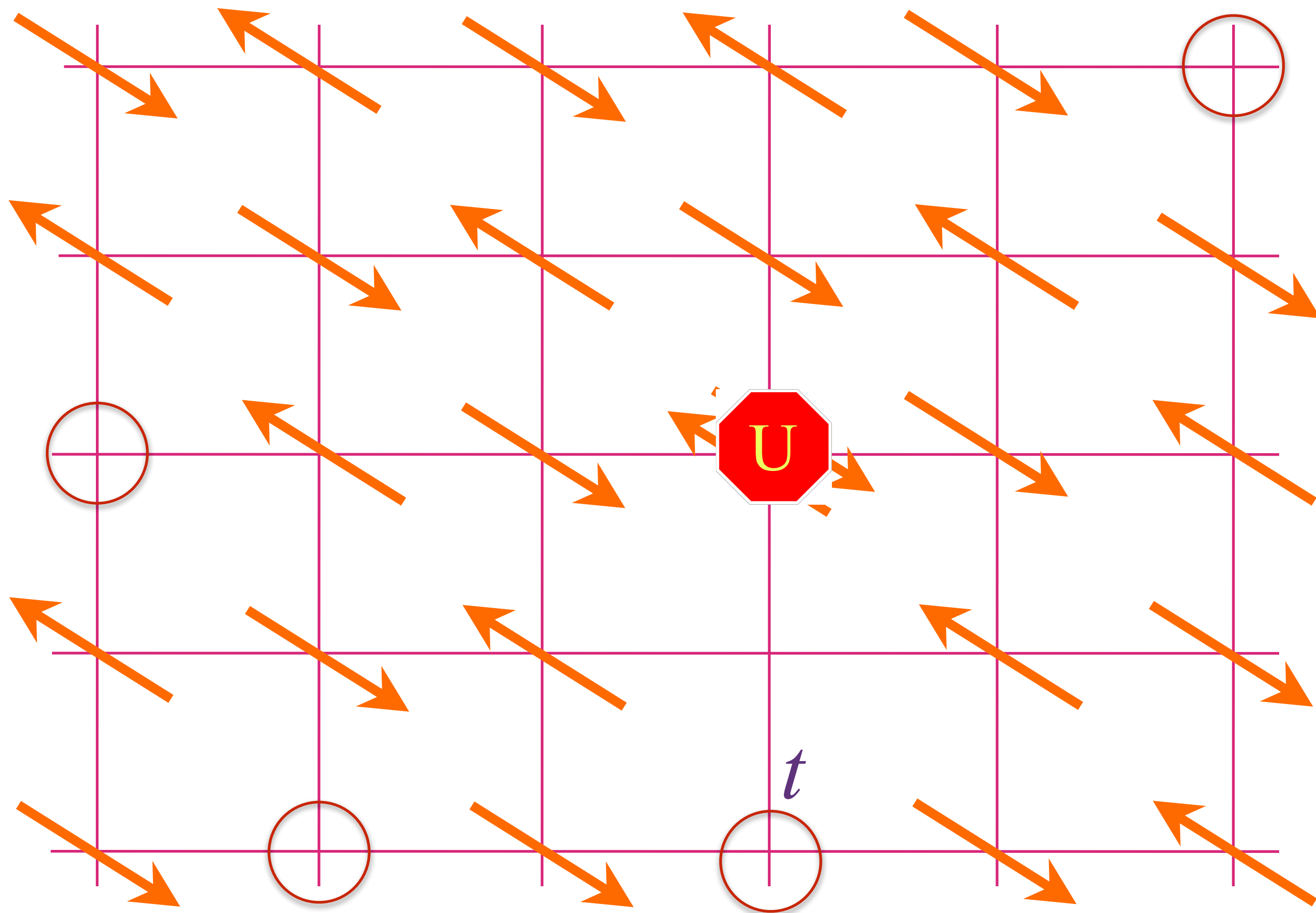

Antiferromagnet
doped with hole
density p

p mobile holes in a
background of
fluctuating spins

$$\mathcal{H}_H = \sum_{\mathbf{p}} \varepsilon_{\mathbf{p}} c_{\mathbf{p}\sigma}^\dagger c_{\mathbf{p}\sigma} + U \sum_i n_{i\uparrow} n_{i\downarrow}$$

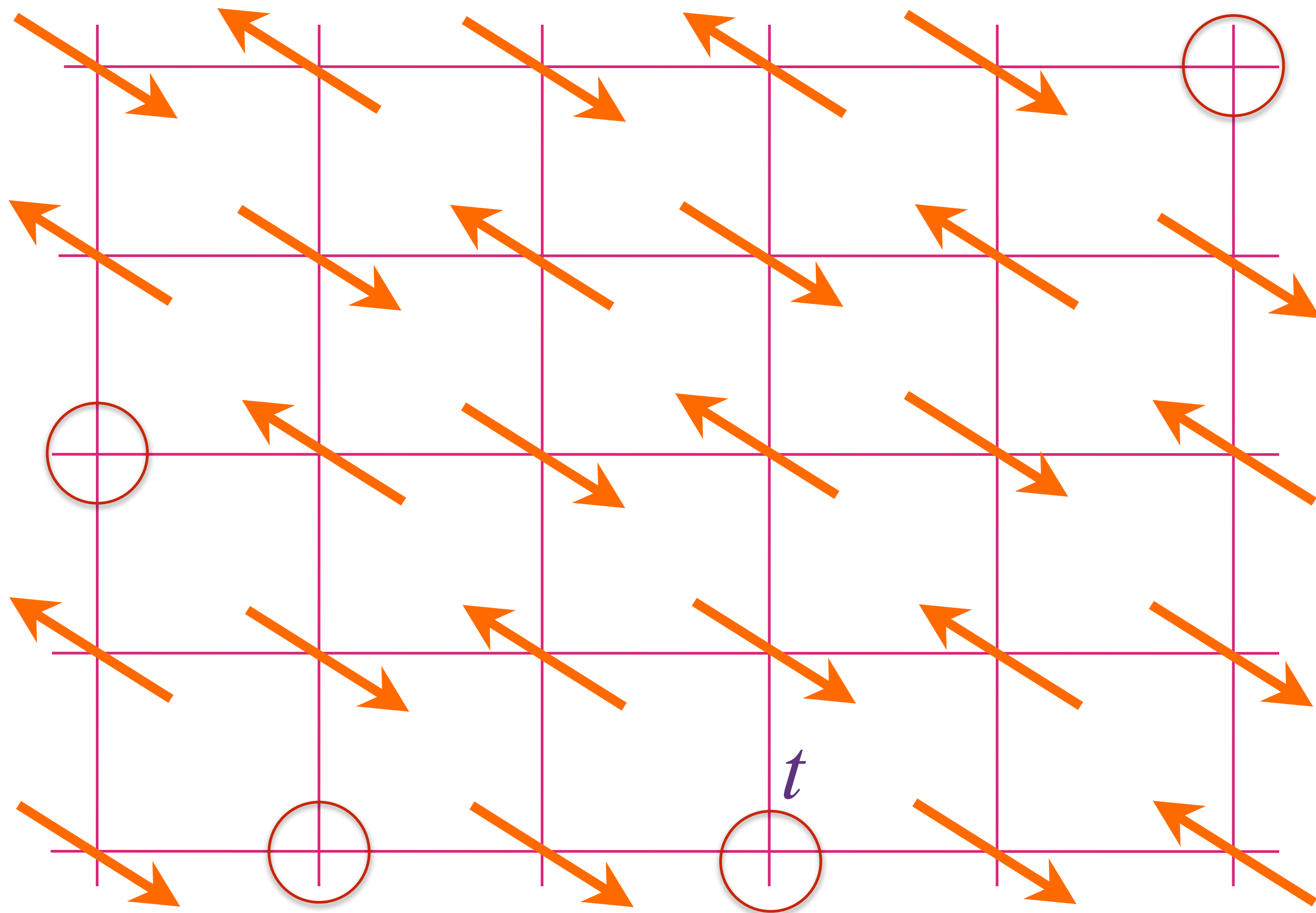

Antiferromagnet
doped with hole
density p

p mobile holes in a
background of
fluctuating spins

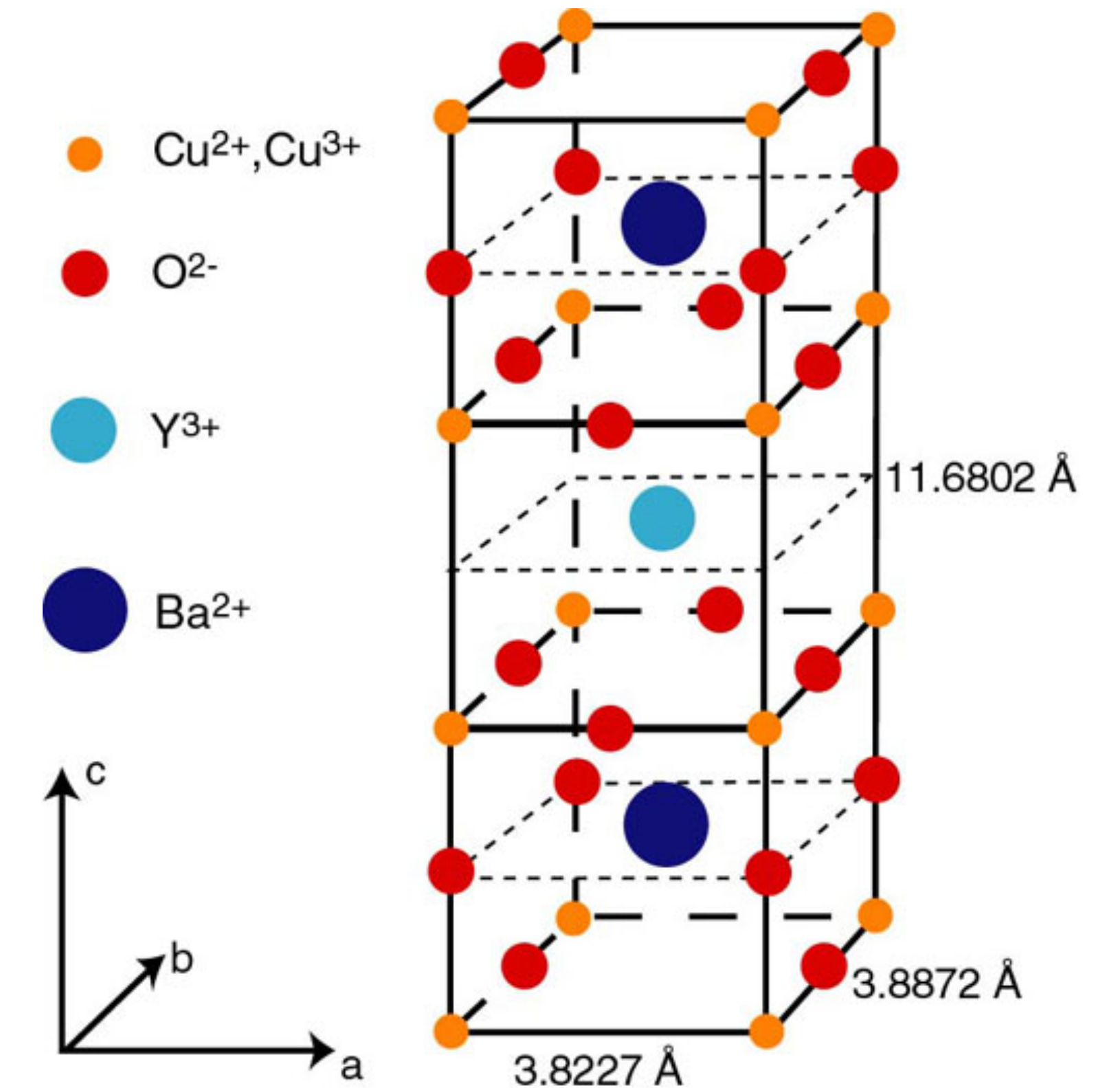
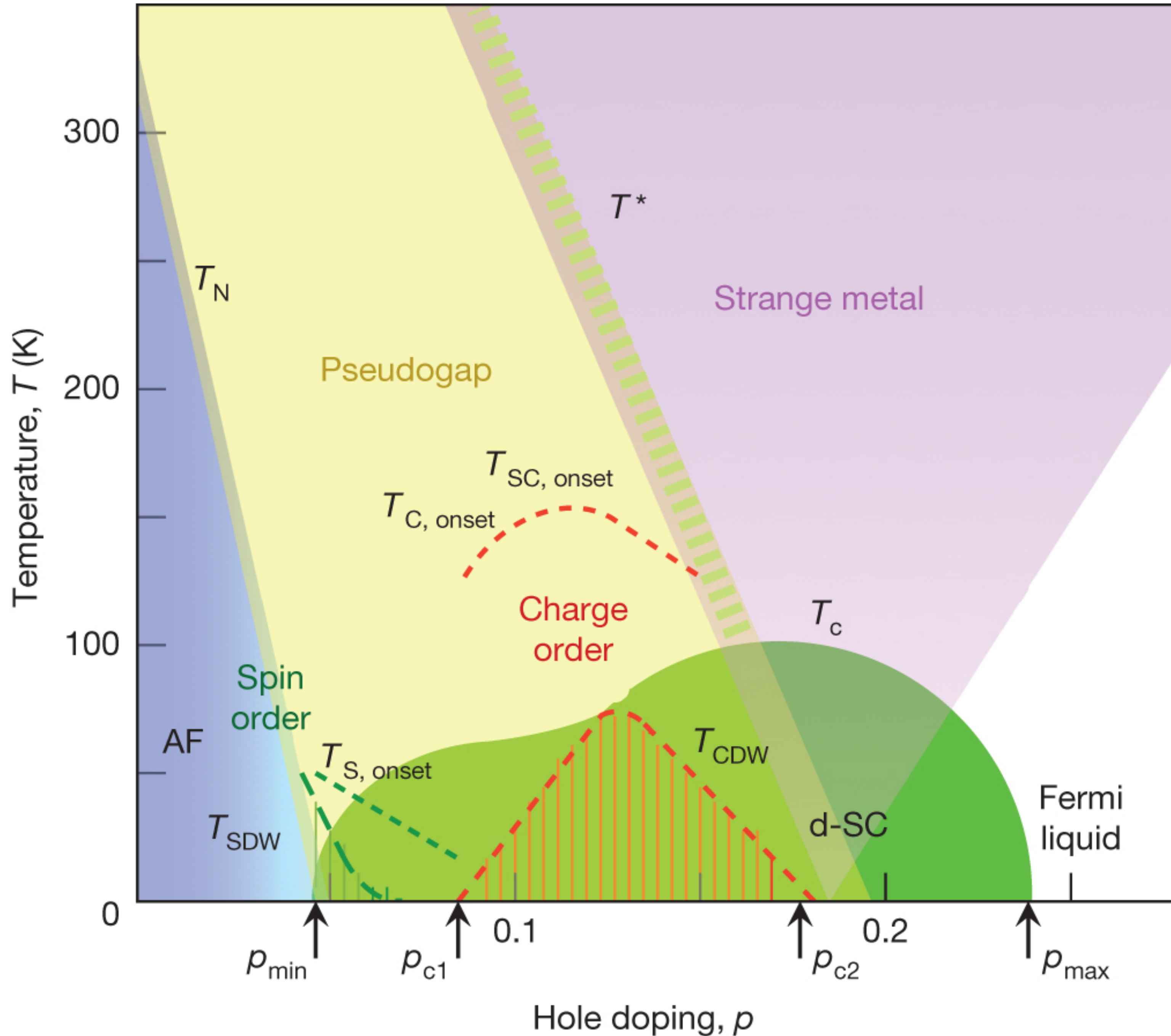

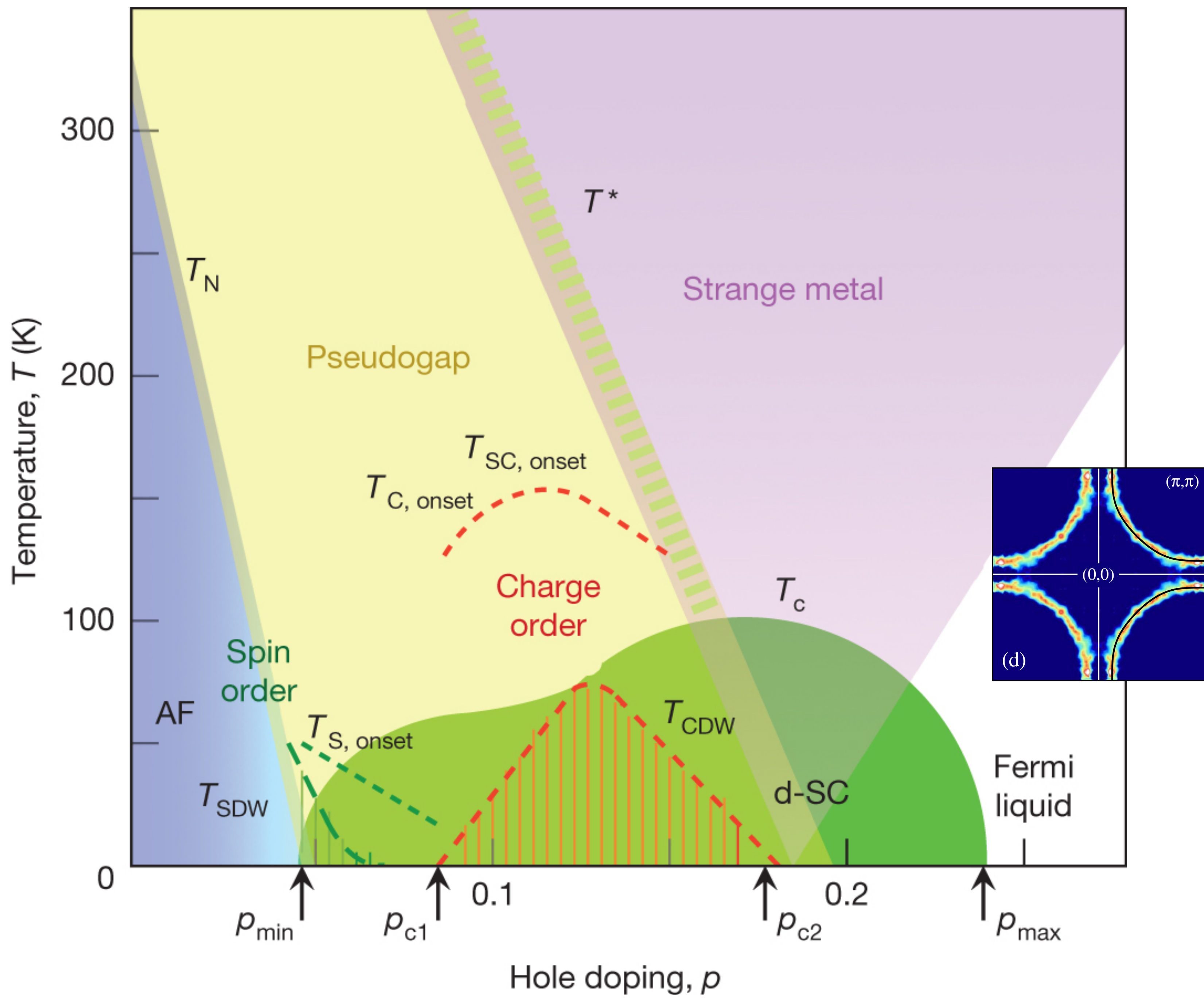

Fermi liquid
in the
overdoped metal

Photoemission at large p

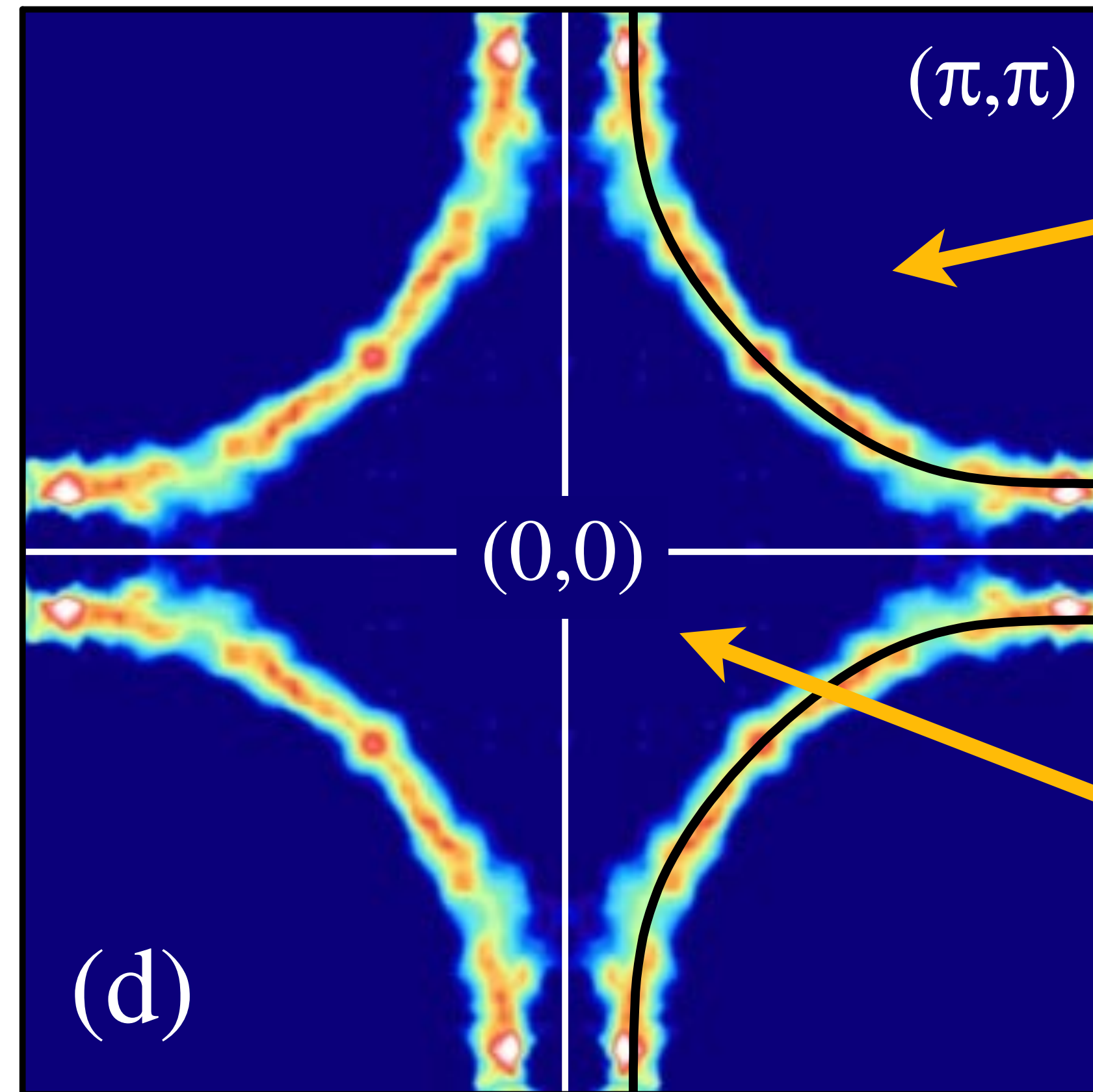

$1+p$ holes

Overdoped $\text{Tl}_2\text{Ba}_2\text{CuO}_{6+\delta}$
 $T_c = 30\text{K}$

$1-p$ electrons

$1+p$ mobile holes in a filled band of 2 electrons per site

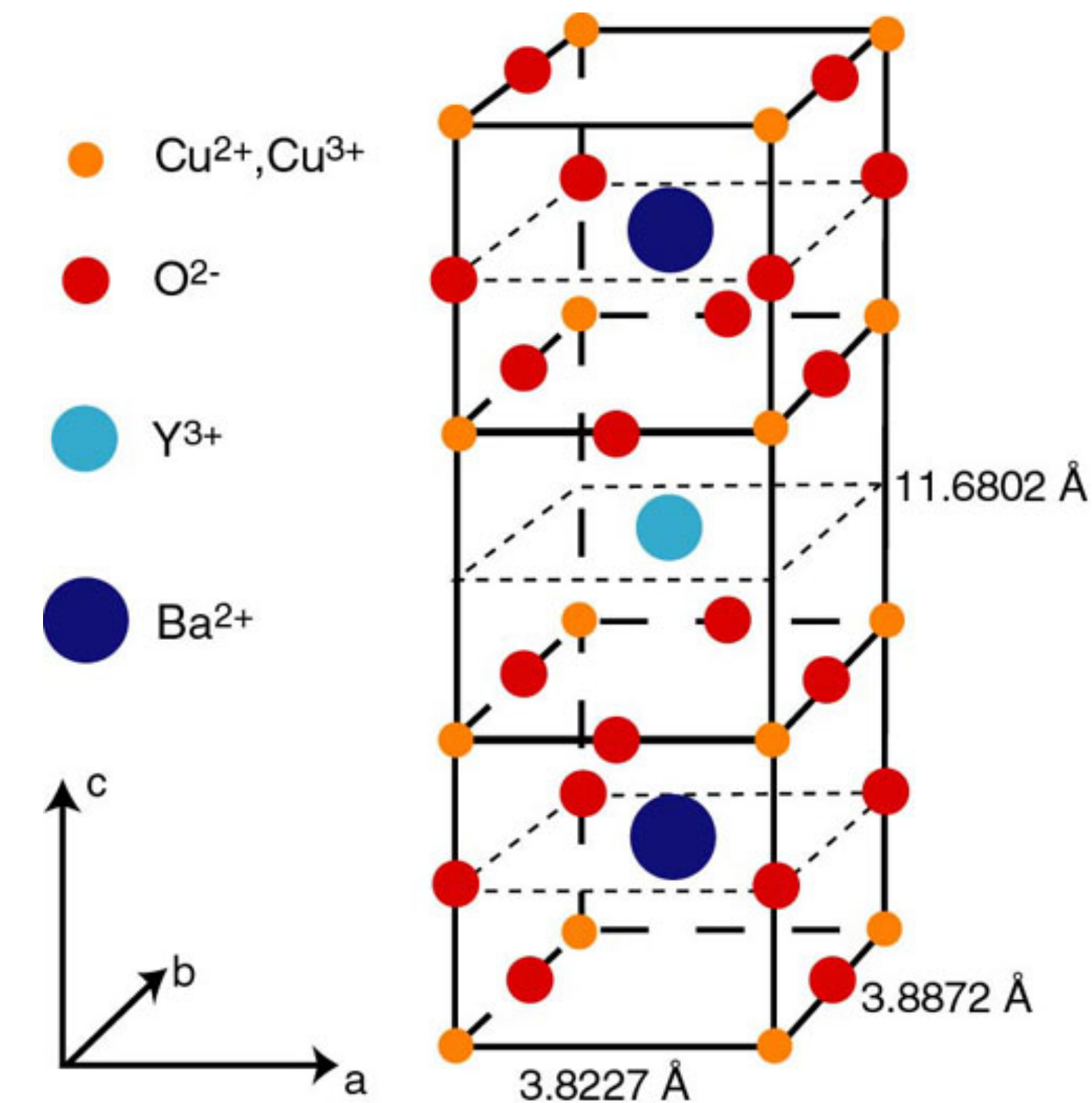
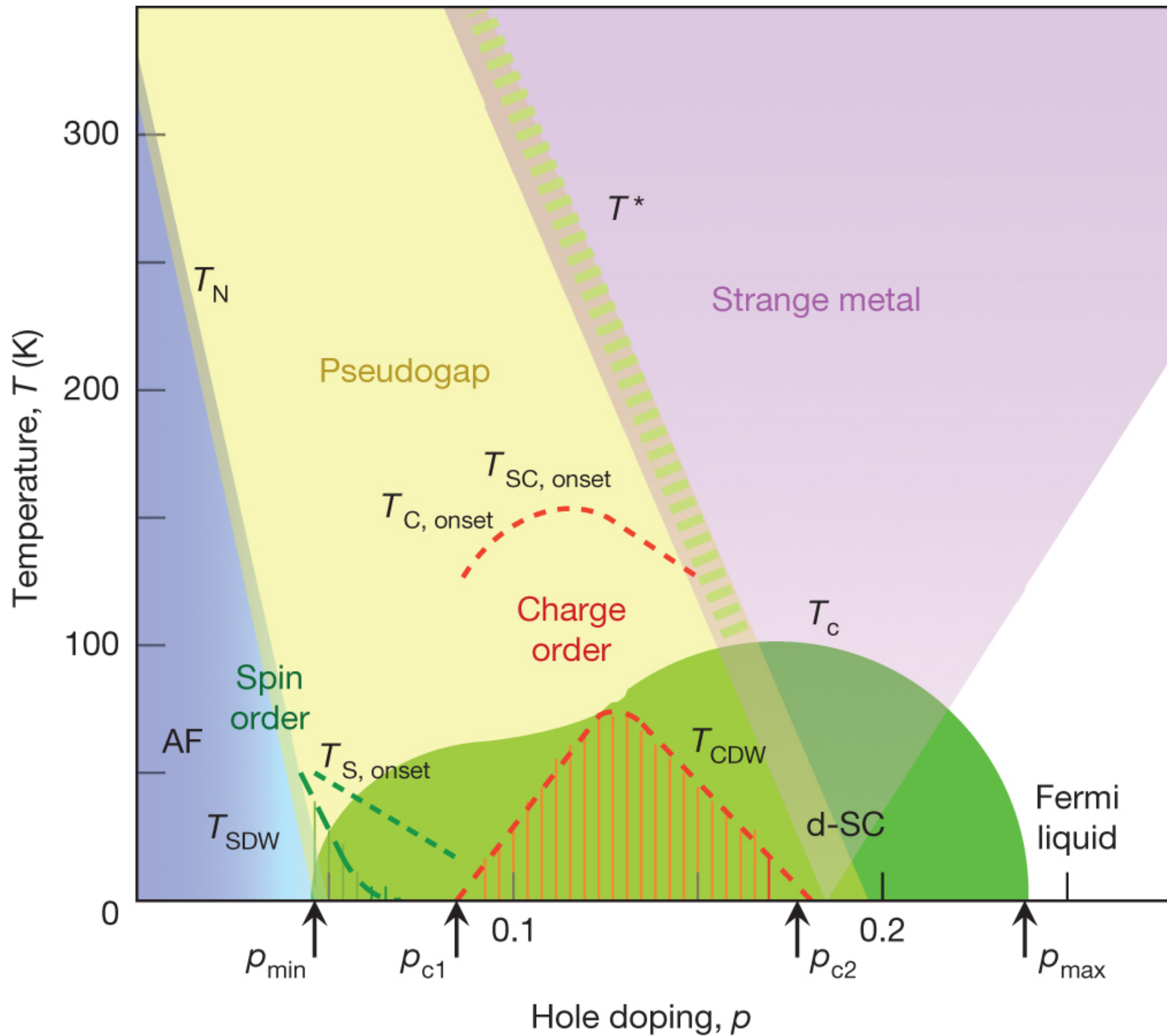

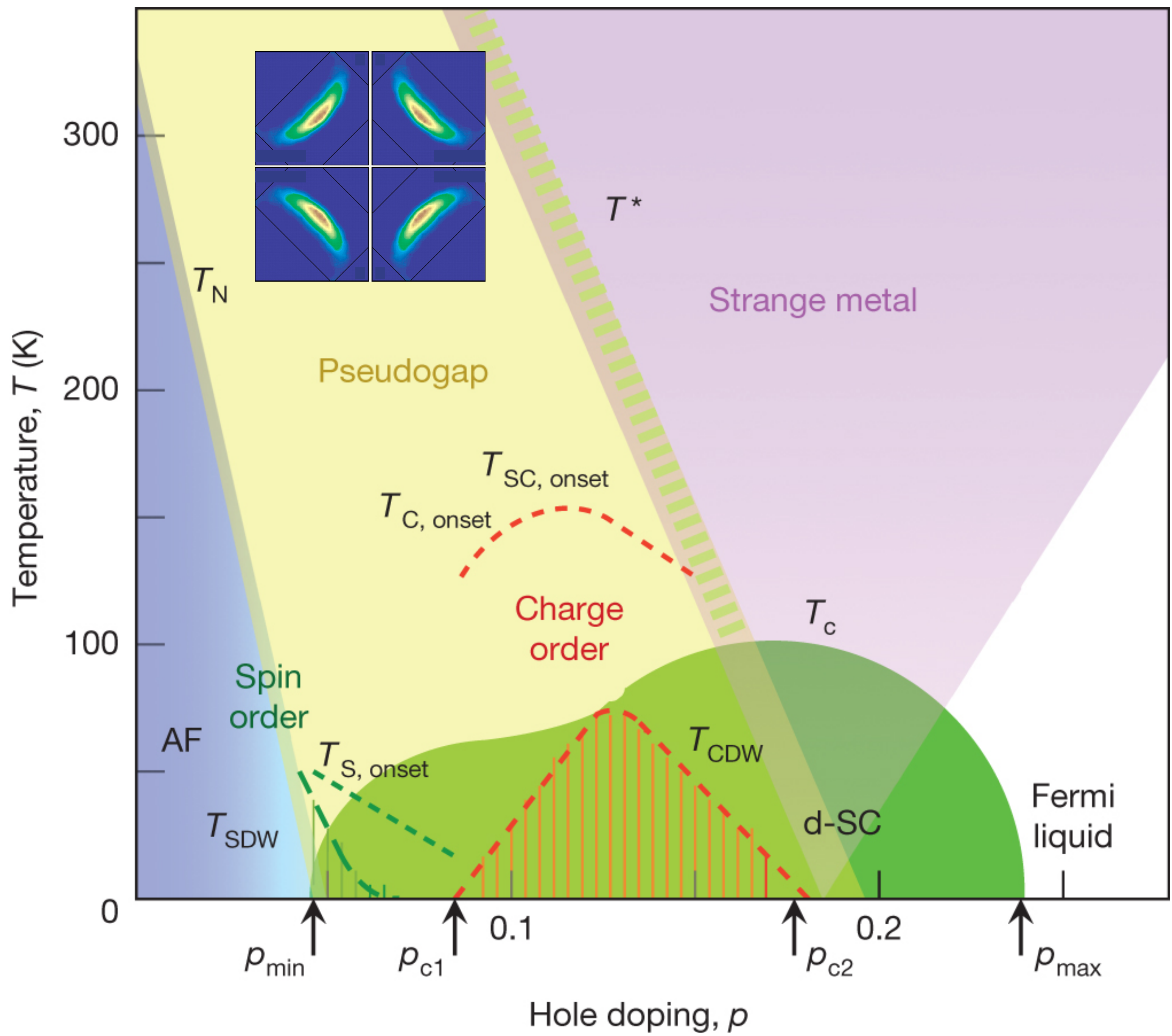

Pseudogap metal with “Fermi arcs”

Hole pocket Fermi surfaces
of size p with
charge e , spin-1/2 quasiparticles

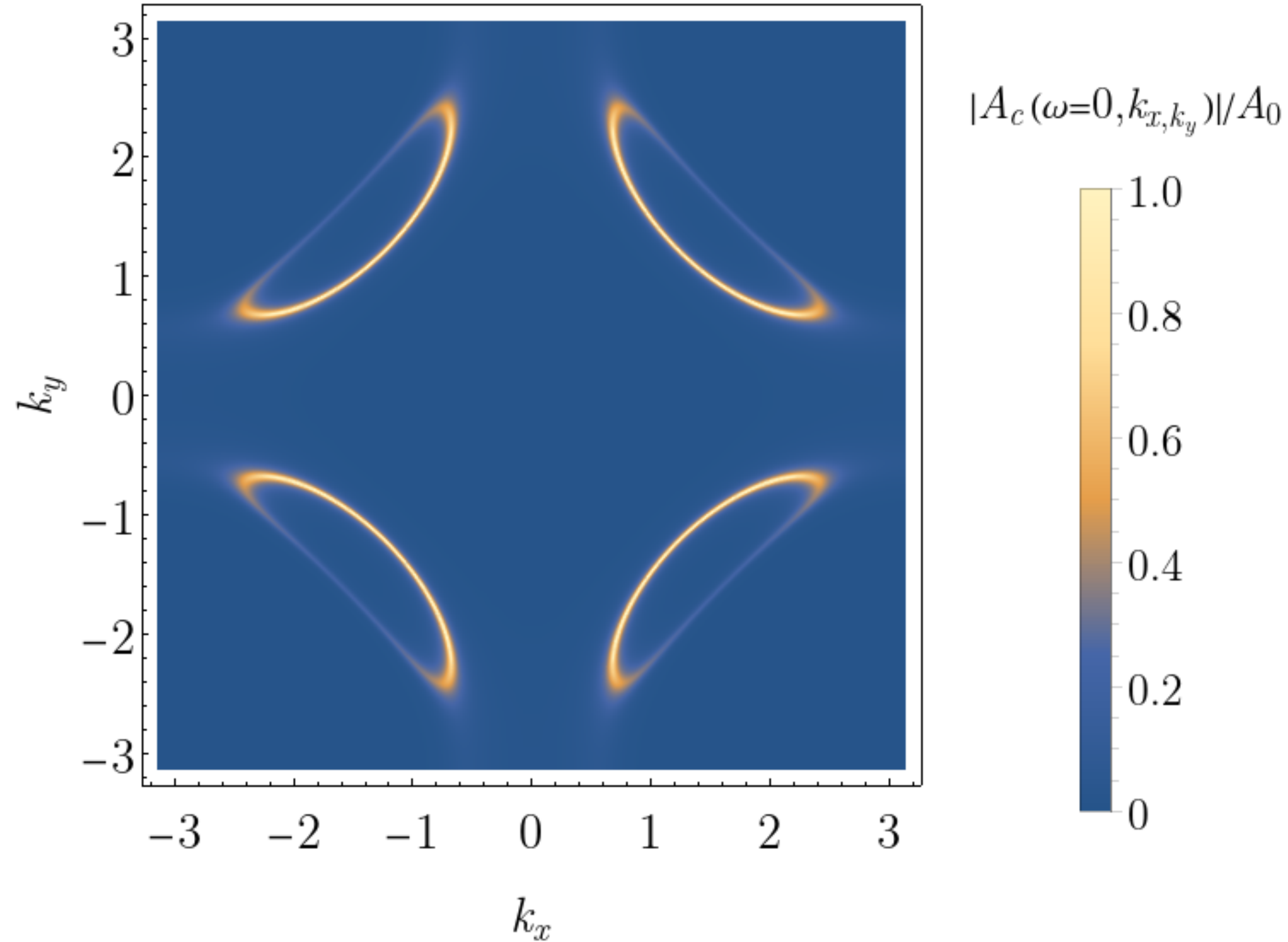

Kai-Yu Yang, T. M. Rice, Fu-Chun Zhang,
Phys. Rev. B **73**, 174501 (2006).
T. D. Stanescu and G. Kotliar,
Phys. Rev. B **74**, 125110 (2006).
C. Berthod, T. Giamarchi, S. Biermann, and A. Georges,
Phys. Rev. Lett. **97**, 136401 (2006).
S. Sakai, Y. Motome, M. Imada,
Phys. Rev. Lett. **102**, 056404 (2009).
J. Skolimowski and M. Fabrizio,
Phys. Rev. B **106**, 045109 (2022).

Y. Qi and S. Sachdev *Phys. Rev. B* **81**, 115129 (2010)

E. Mascot, A. Nikolaenko, M. Tikhanovskaya, Ya-Hui Zhang, D. K. Morr, and
S. Sachdev, *Phys. Rev. B* **105**, 075146 (2022)

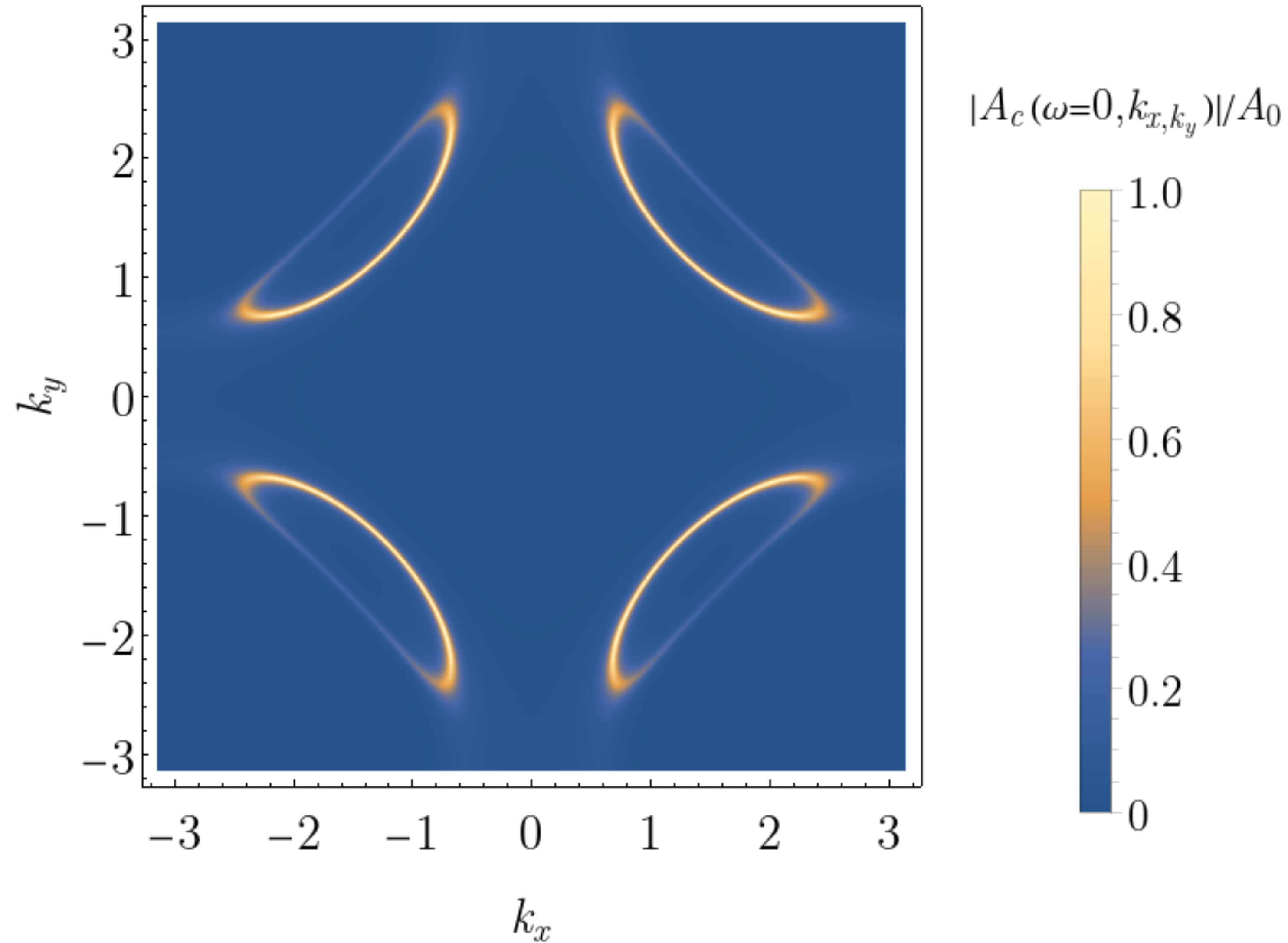

Hole pocket Fermi surfaces
of size p with
charge e , spin-1/2 quasiparticles

Kai-Yu Yang, T. M. Rice, Fu-Chun Zhang,
Phys. Rev. B **73**, 174501 (2006).

T. D. Stanescu and G. Kotliar,
Phys. Rev. B **74**, 125110 (2006).

C. Berthod, T. Giamarchi, S. Biermann, and A. Georges,
Phys. Rev. Lett. **97**, 136401 (2006).

S. Sakai, Y. Motome, M. Imada,
Phys. Rev. Lett. **102**, 056404 (2009).

J. Skolimowski and M. Fabrizio,
Phys. Rev. B **106**, 045109 (2022).

The Fermi surface does not enclose
the Luttinger volume $(1 + p)$.

Y. Qi and S. Sachdev *Phys. Rev. B* **81**, 115129 (2010)

E. Mascot, A. Nikolaenko, M. Tikhanovskaya, Ya-Hui Zhang, D. K. Morr, and
S. Sachdev, *Phys. Rev. B* **105**, 075146 (2022)

Fermi surface transformation at the pseudogap critical point of a cuprate superconductor

Yawen Fang, Gaël Grissonnanche, Anaëlle Legros, Simon Verret, Francis Laliberté, Clément Collignon, Amirreza Ataei, Maxime Dion, Jianshi Zhou, David Graf, M. J. Lawler, Paul Goddard, Louis Taillefer, and B. J. Ramshaw, *Nature Physics* **18**, 558 (2022)

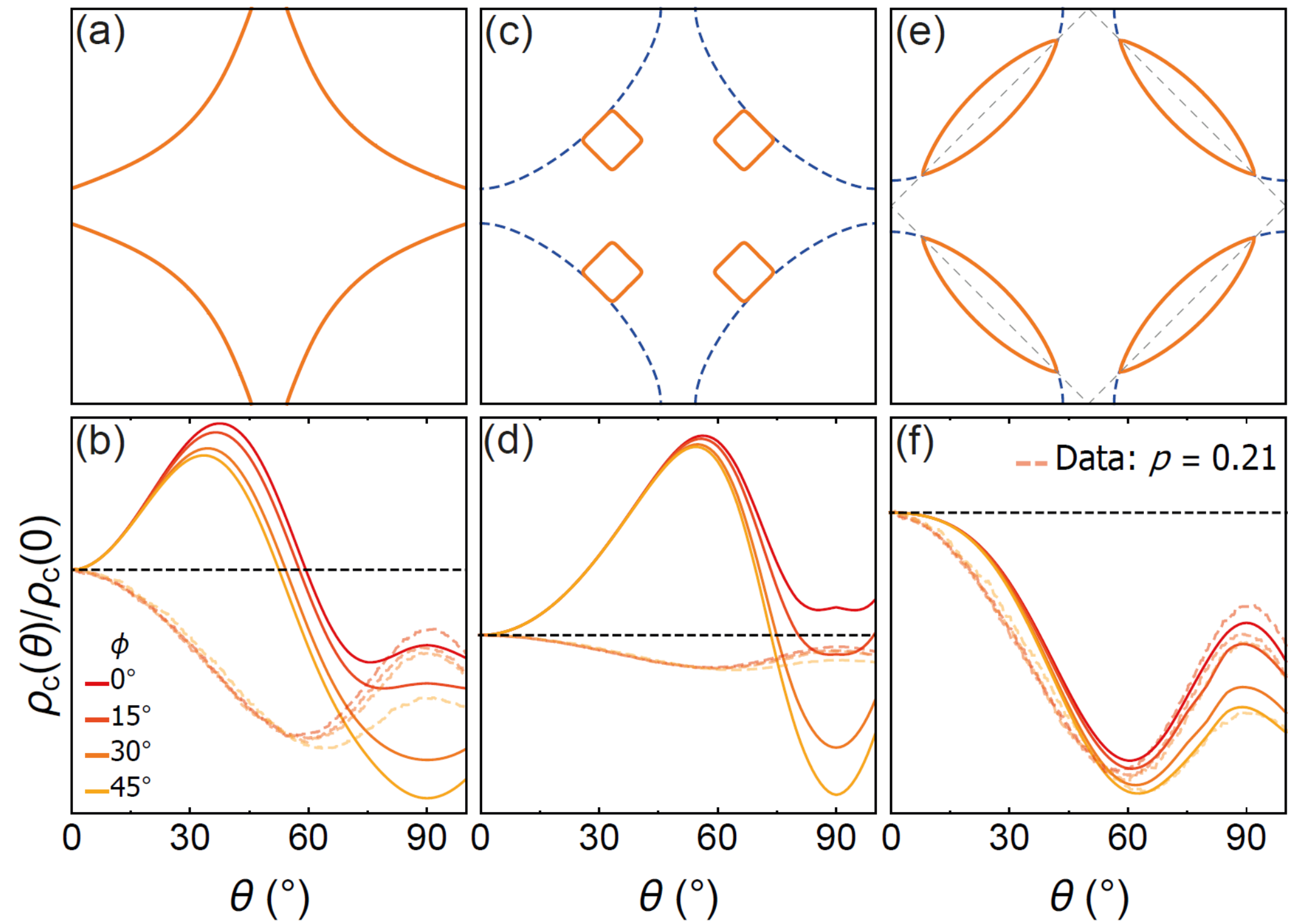
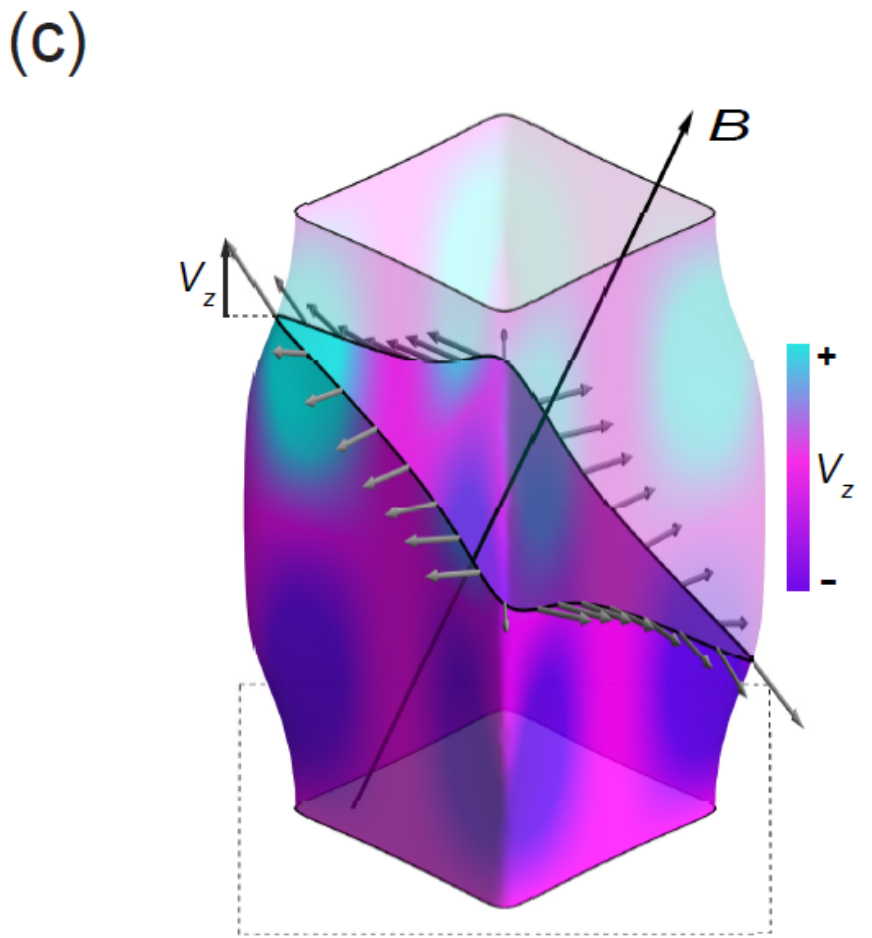
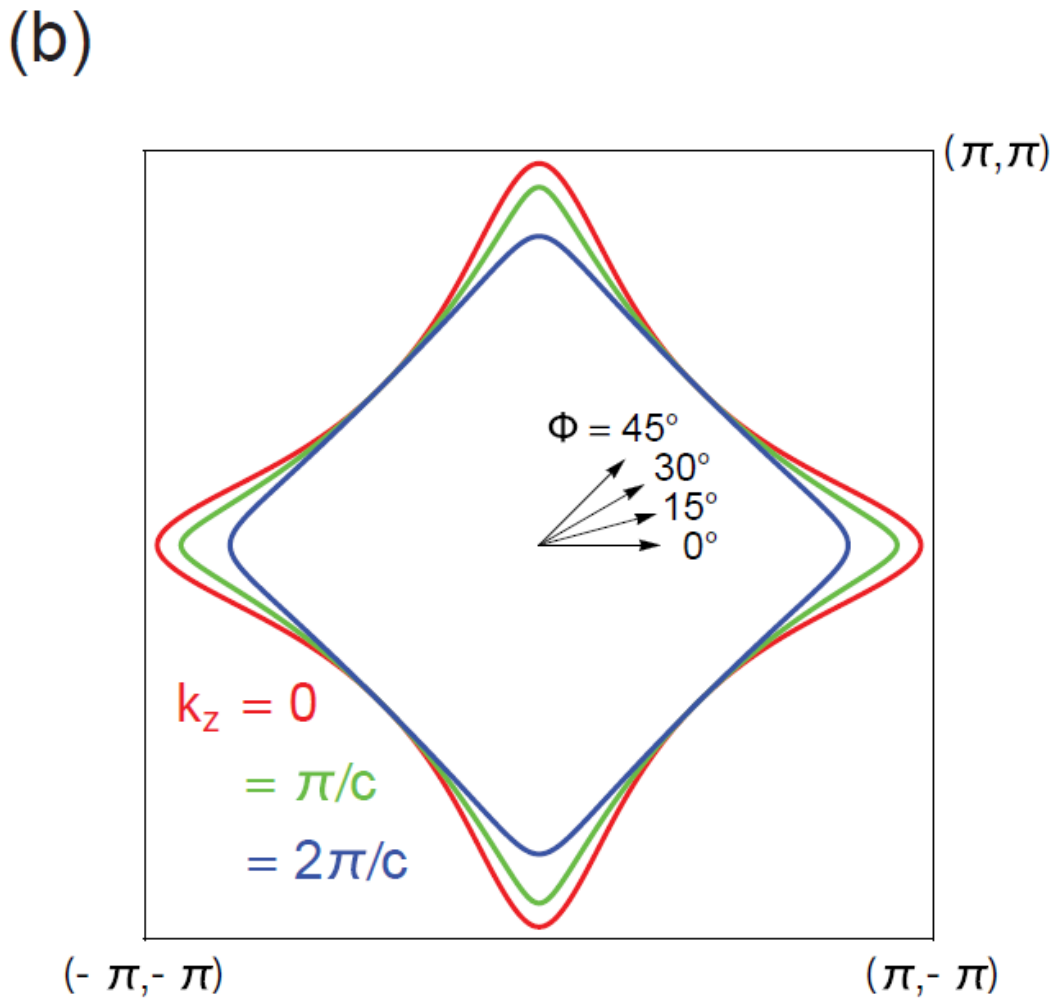
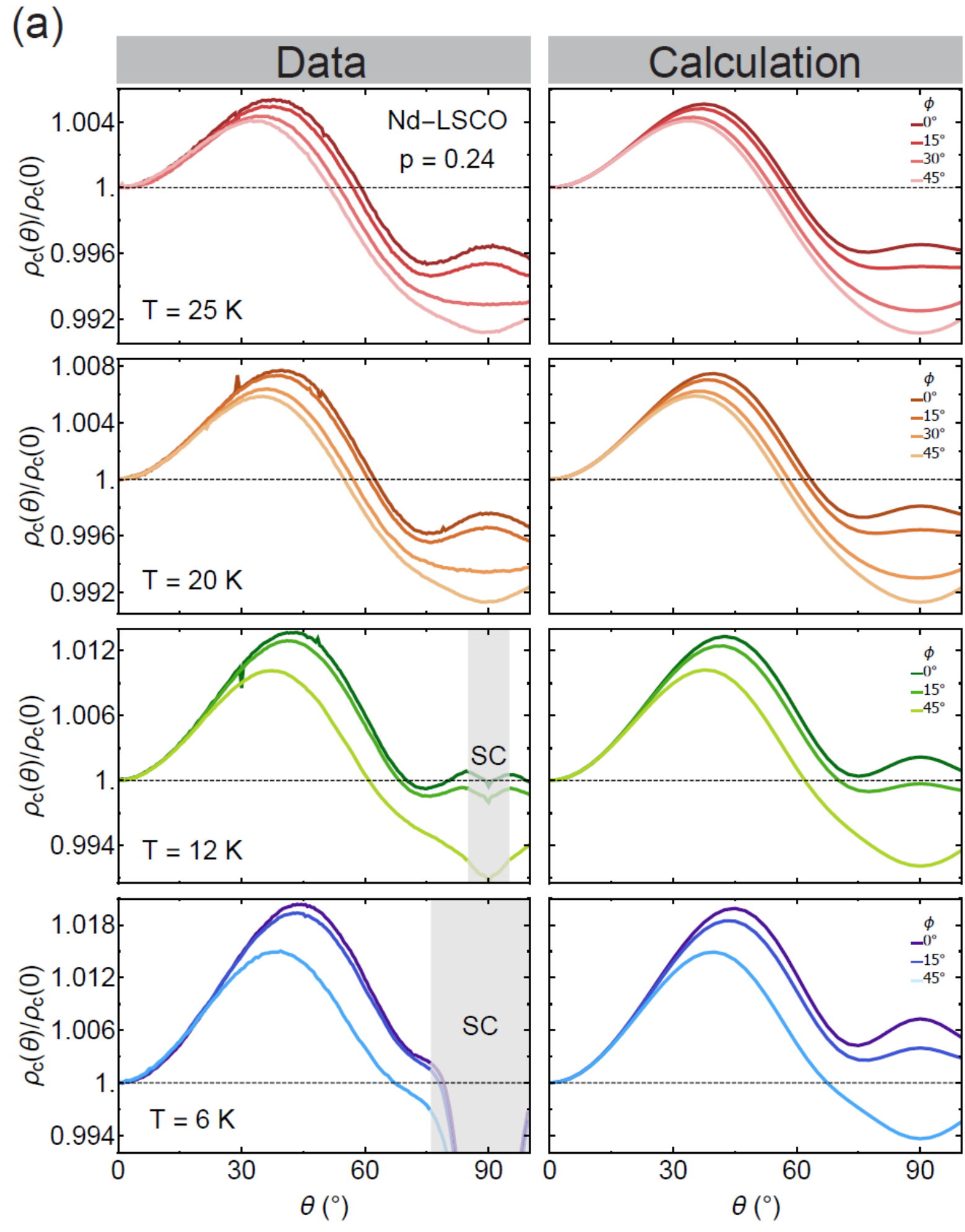

$p > p_c$ Large Fermi surface

$p < p_c$ Reconstructed Fermi surface

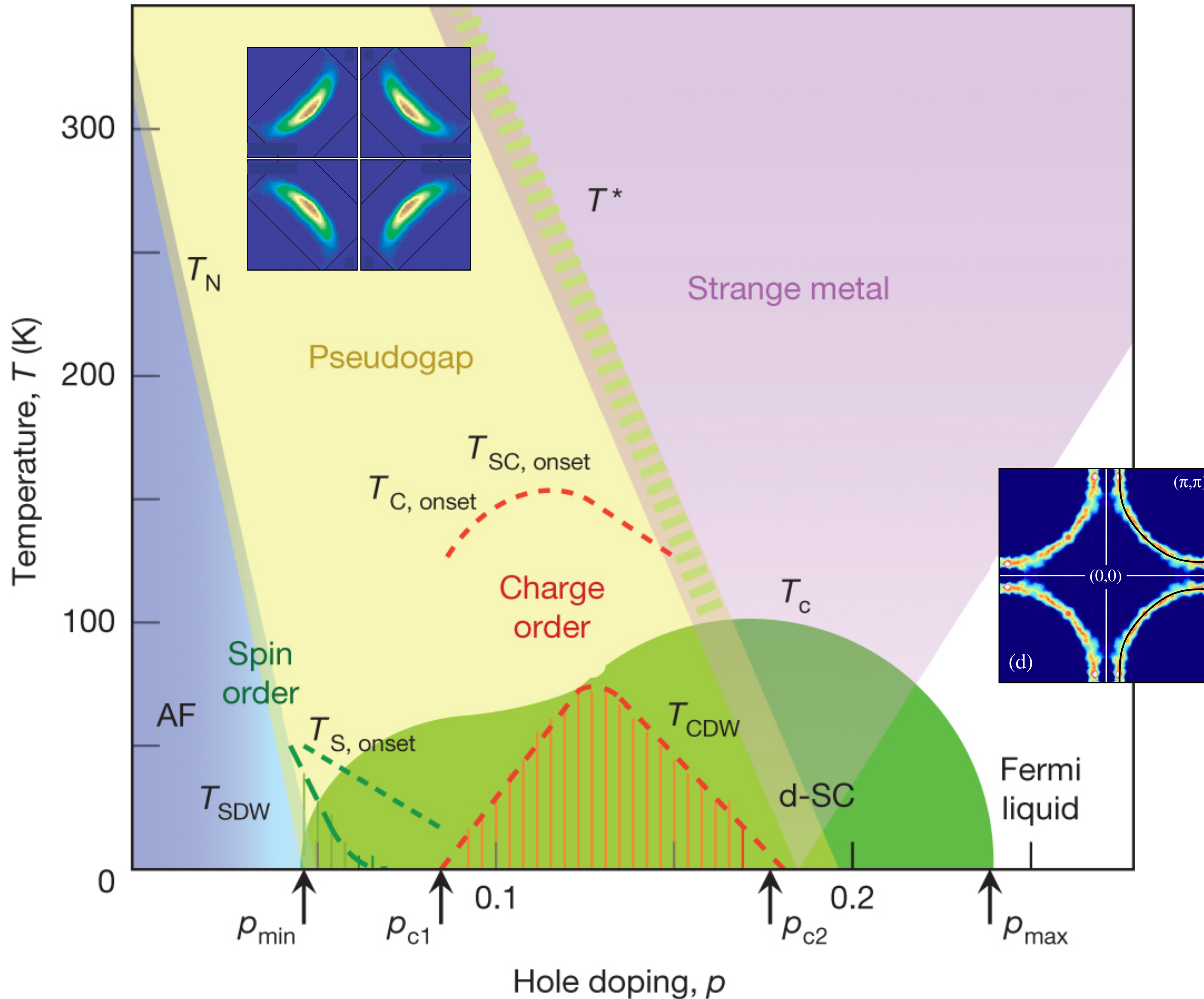

Build a theory for the phase diagram from a theory of the pseudogap metal as a ‘metastable’ $T = 0$ quantum phase.

Lowest T phases obtained from pseudogap metal should connect smoothly to conventionally order phases obtained from the Fermi liquid.

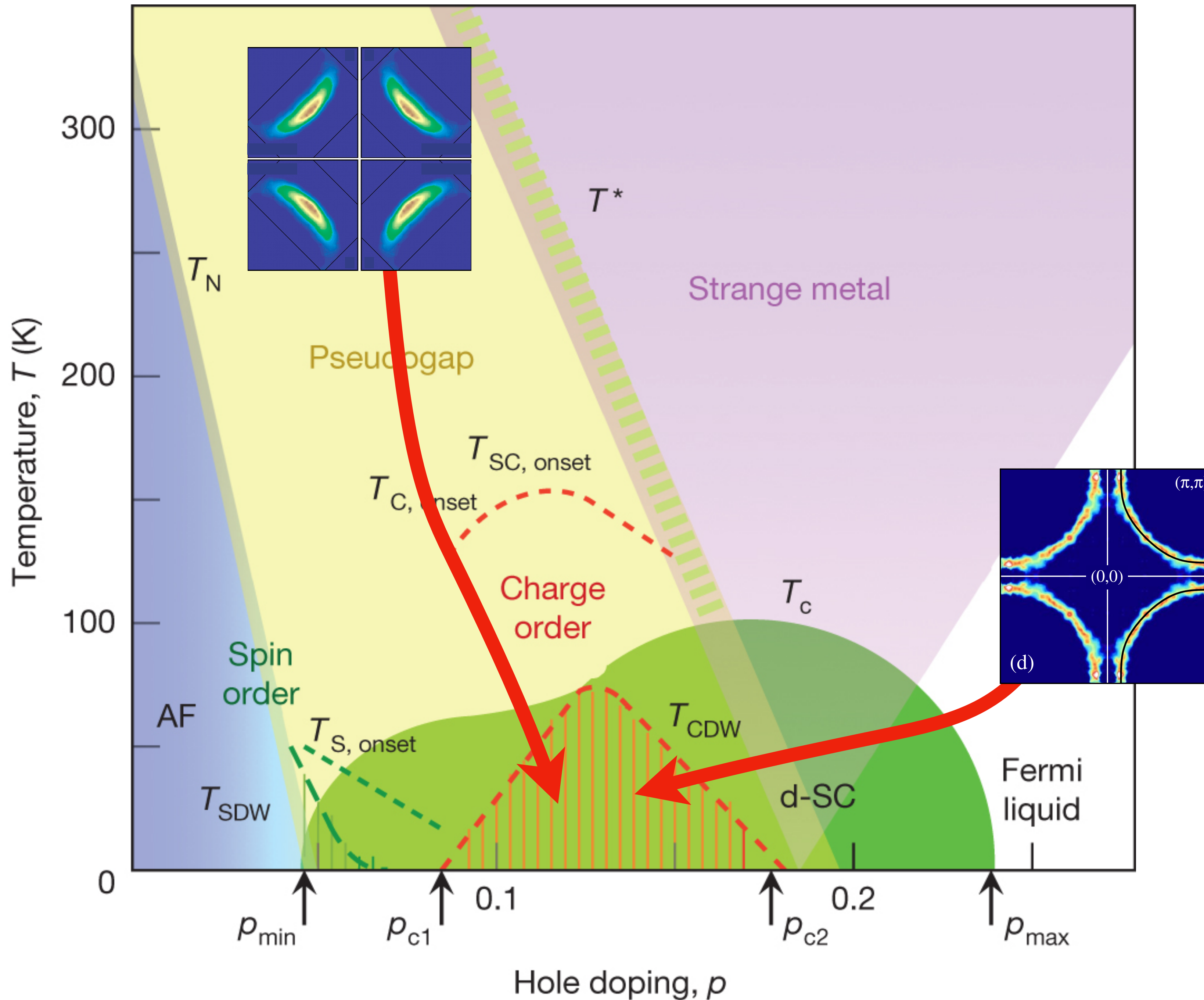

Build a theory for the phase diagram from a theory of the pseudogap metal as a ‘metastable’ $T = 0$ quantum phase.

Lowest T phases obtained from pseudogap metal should connect smoothly to conventionally order phases obtained from the Fermi liquid.

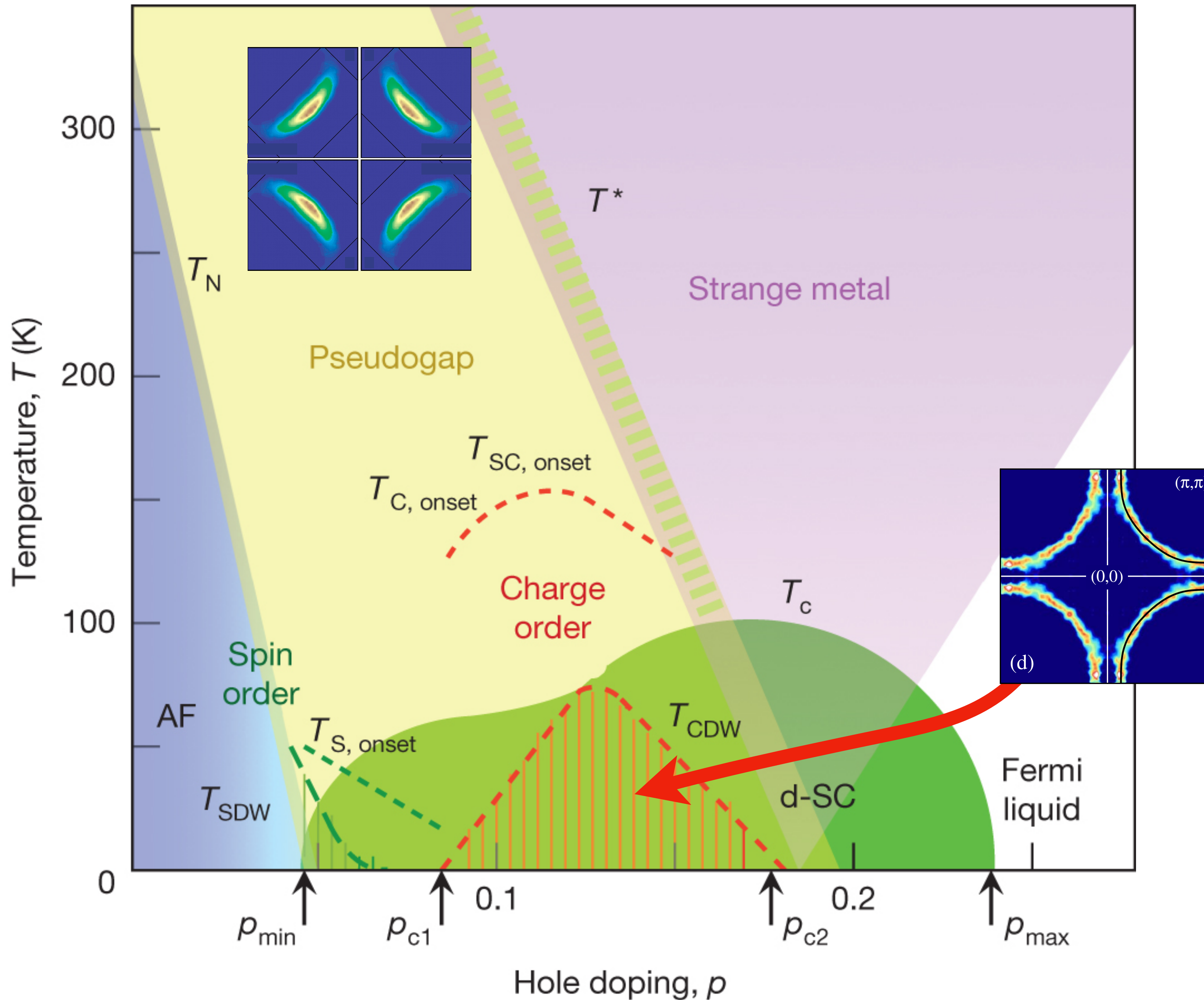

Build a theory for the phase diagram from a theory of the pseudogap metal as a ‘metastable’ $T = 0$ quantum phase.

Lowest T phases obtained from pseudogap metal should connect smoothly to conventionally order phases obtained from the Fermi liquid.

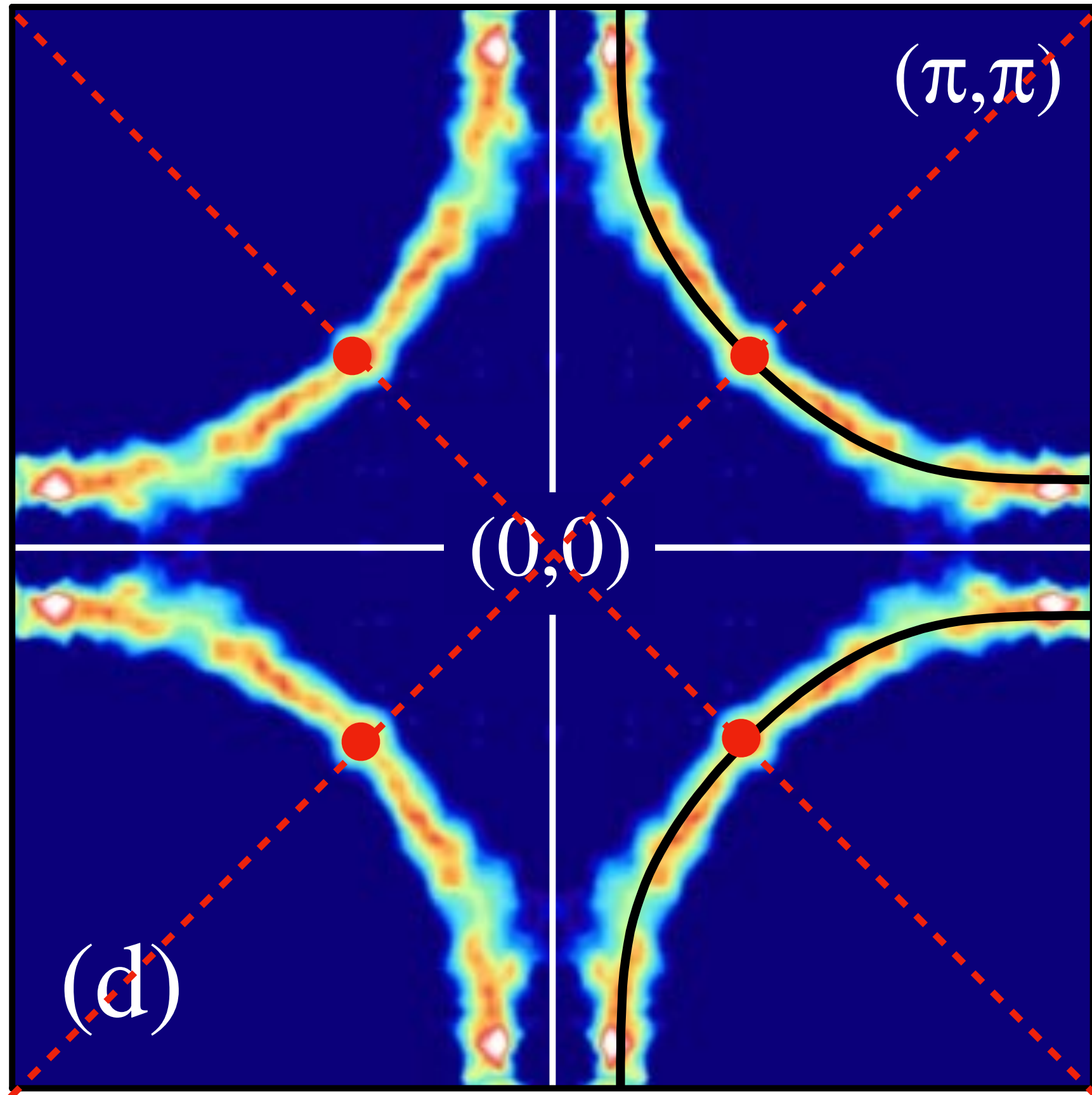

BCS/Bogoliubov quasiparticles
in a d -wave superconductor

$$E_{\mathbf{k}} = \left(\varepsilon_{\mathbf{k}}^2 + \Delta_{\mathbf{k}}^2 \right)^{1/2}$$

$$\Delta_{\mathbf{k}} = \Delta_0 (\cos k_x - \cos k_y)$$

4 nodal points where

$$E_{\mathbf{k}_0 + \mathbf{q}} = \left(v_F^2 q_{\perp}^2 + v_{\Delta}^2 q_{\parallel}^2 \right)^{1/2}$$

with $v_F \gg v_{\Delta}$.

BCS/Bogoliubov quasiparticles in a *d*-wave superconductor

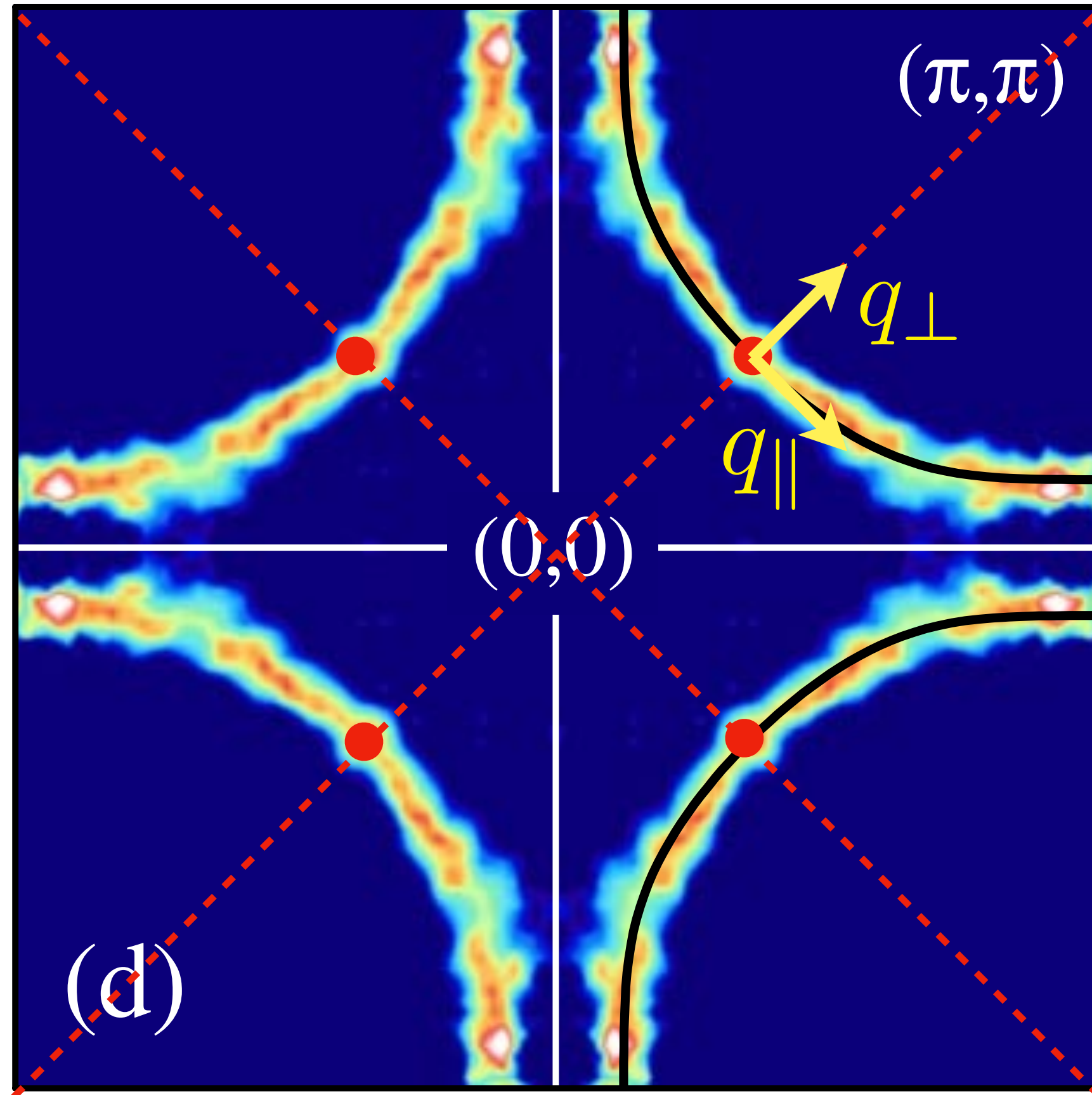

$$E_{\mathbf{k}} = \left(\varepsilon_{\mathbf{k}}^2 + \Delta_{\mathbf{k}}^2 \right)^{1/2}$$

$$\Delta_{\mathbf{k}} = \Delta_0 (\cos k_x - \cos k_y)$$

4 nodal points where

$$E_{\mathbf{k}_0 + \mathbf{q}} = \left(v_F^2 q_{\perp}^2 + v_{\Delta}^2 q_{\parallel}^2 \right)^{1/2}$$

with $v_F \gg v_{\Delta}$.

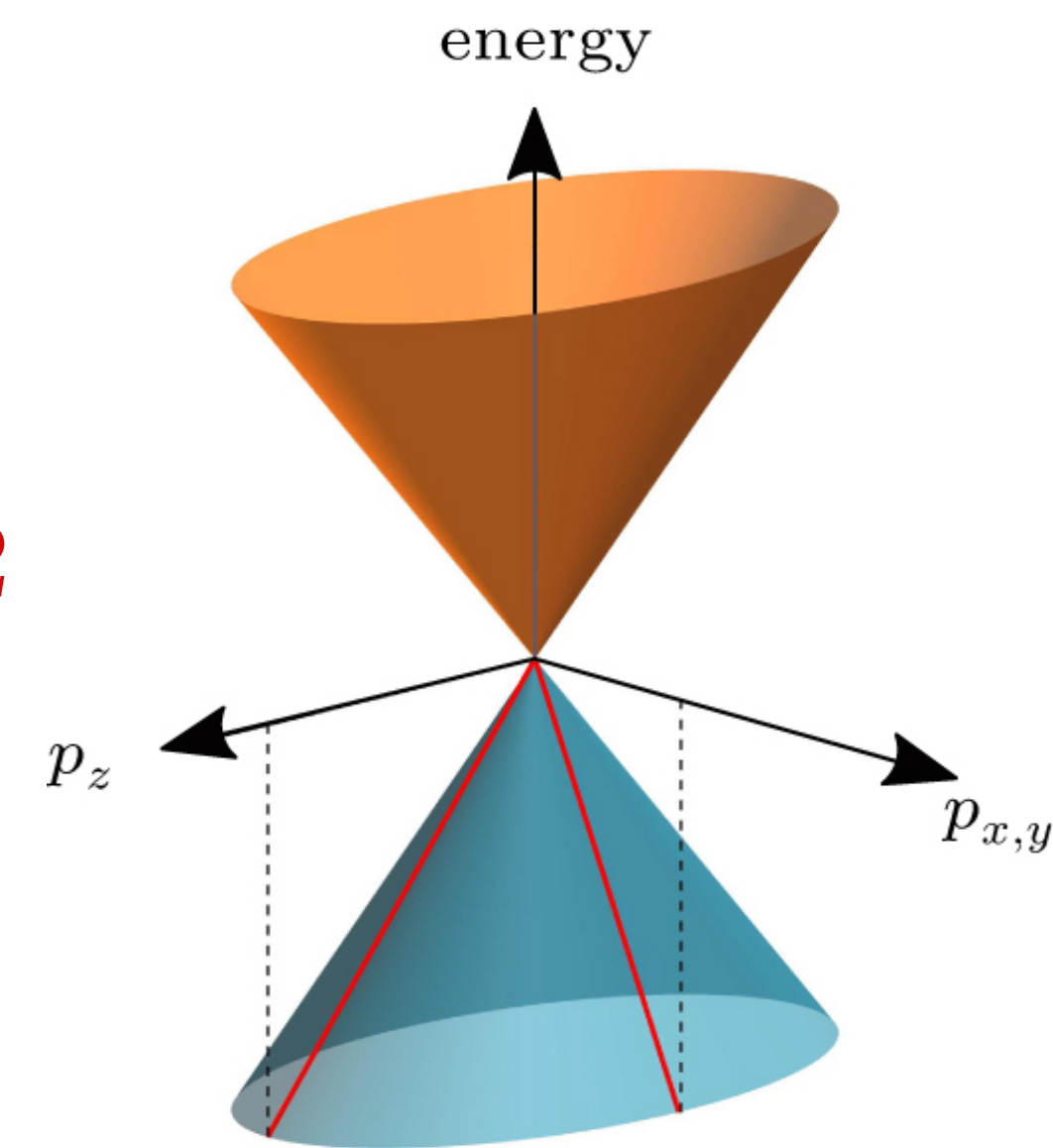

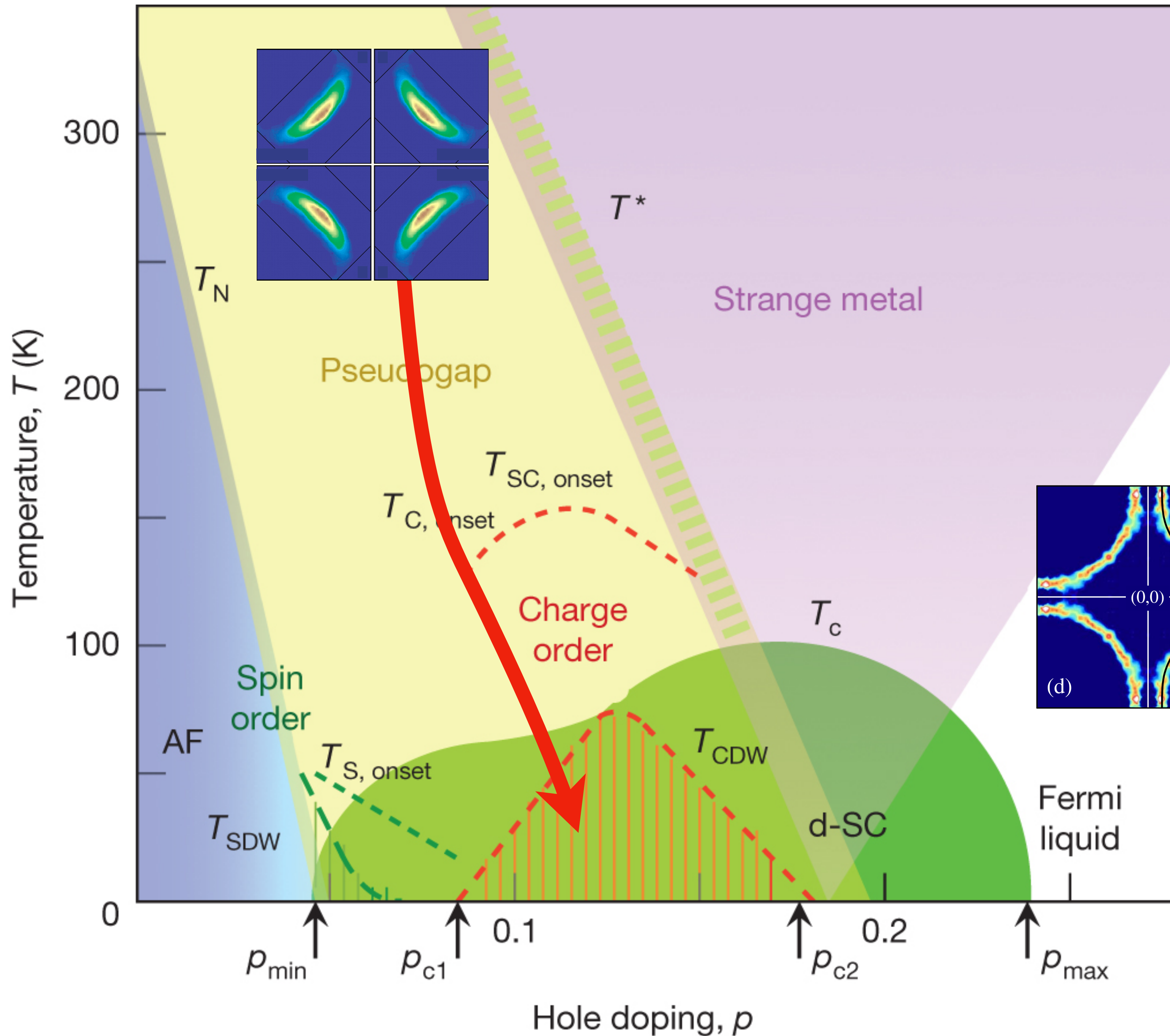

Build a theory for the phase diagram from a theory of the pseudogap metal as a ‘metastable’ $T = 0$ quantum phase.

Lowest T phases obtained from pseudogap metal should connect smoothly to conventionally order phases obtained from the Fermi liquid.

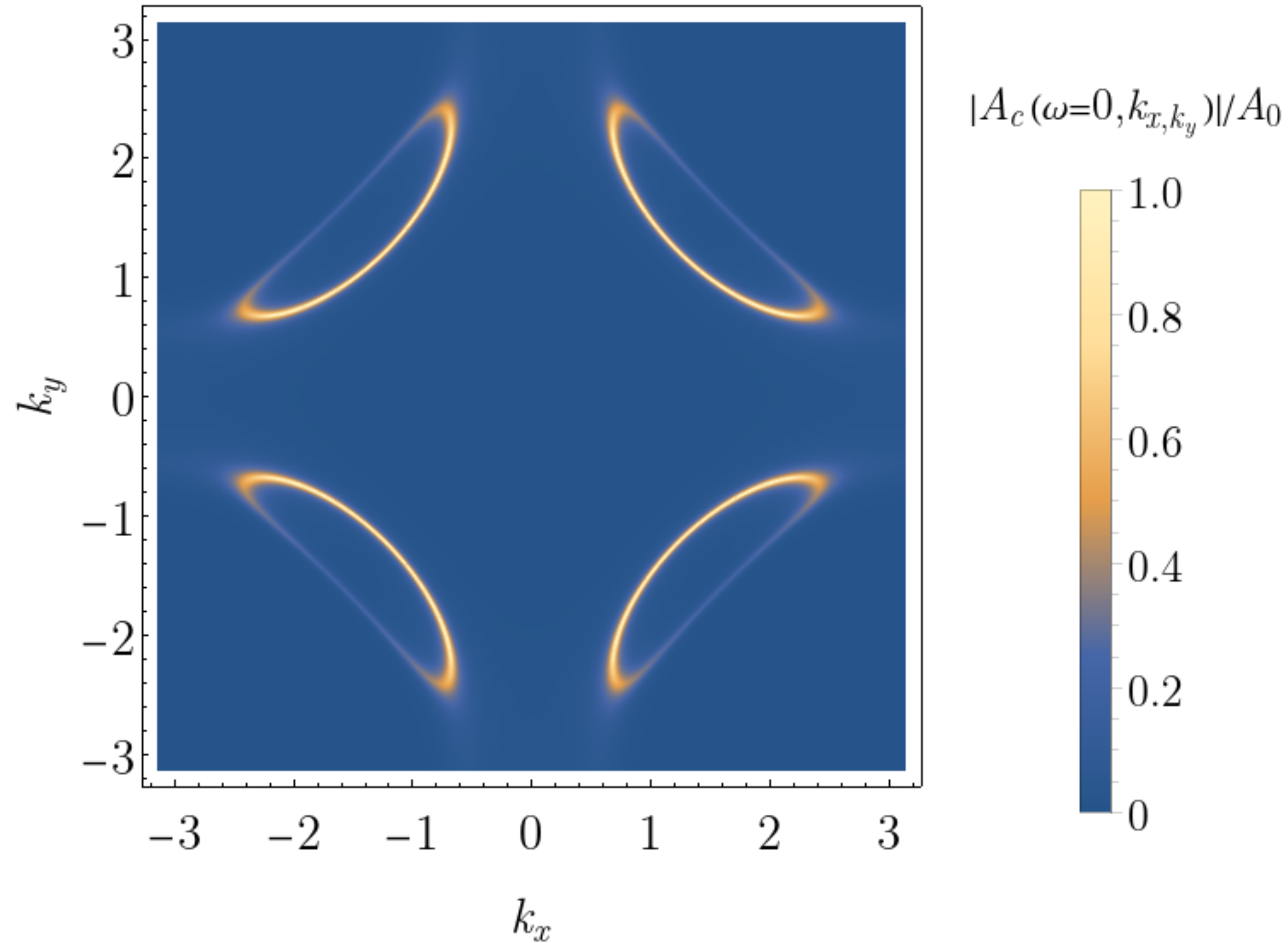

Hole pocket Fermi surfaces
of size p with
charge e , spin-1/2 quasiparticles

Kai-Yu Yang, T. M. Rice, Fu-Chun Zhang,
Phys. Rev. B **73**, 174501 (2006).

T. D. Stanescu and G. Kotliar,
Phys. Rev. B **74**, 125110 (2006).

C. Berthod, T. Giamarchi, S. Biermann, and A. Georges,
Phys. Rev. Lett. **97**, 136401 (2006).

S. Sakai, Y. Motome, M. Imada,
Phys. Rev. Lett. **102**, 056404 (2009).

J. Skolimowski and M. Fabrizio,
Phys. Rev. B **106**, 045109 (2022).

The Fermi surface does not enclose
the Luttinger volume $(1 + p)$.

Y. Qi and S. Sachdev *Phys. Rev. B* **81**, 115129 (2010)

E. Mascot, A. Nikolaenko, M. Tikhanovskaya, Ya-Hui Zhang, D. K. Morr, and
S. Sachdev, *Phys. Rev. B* **105**, 075146 (2022)

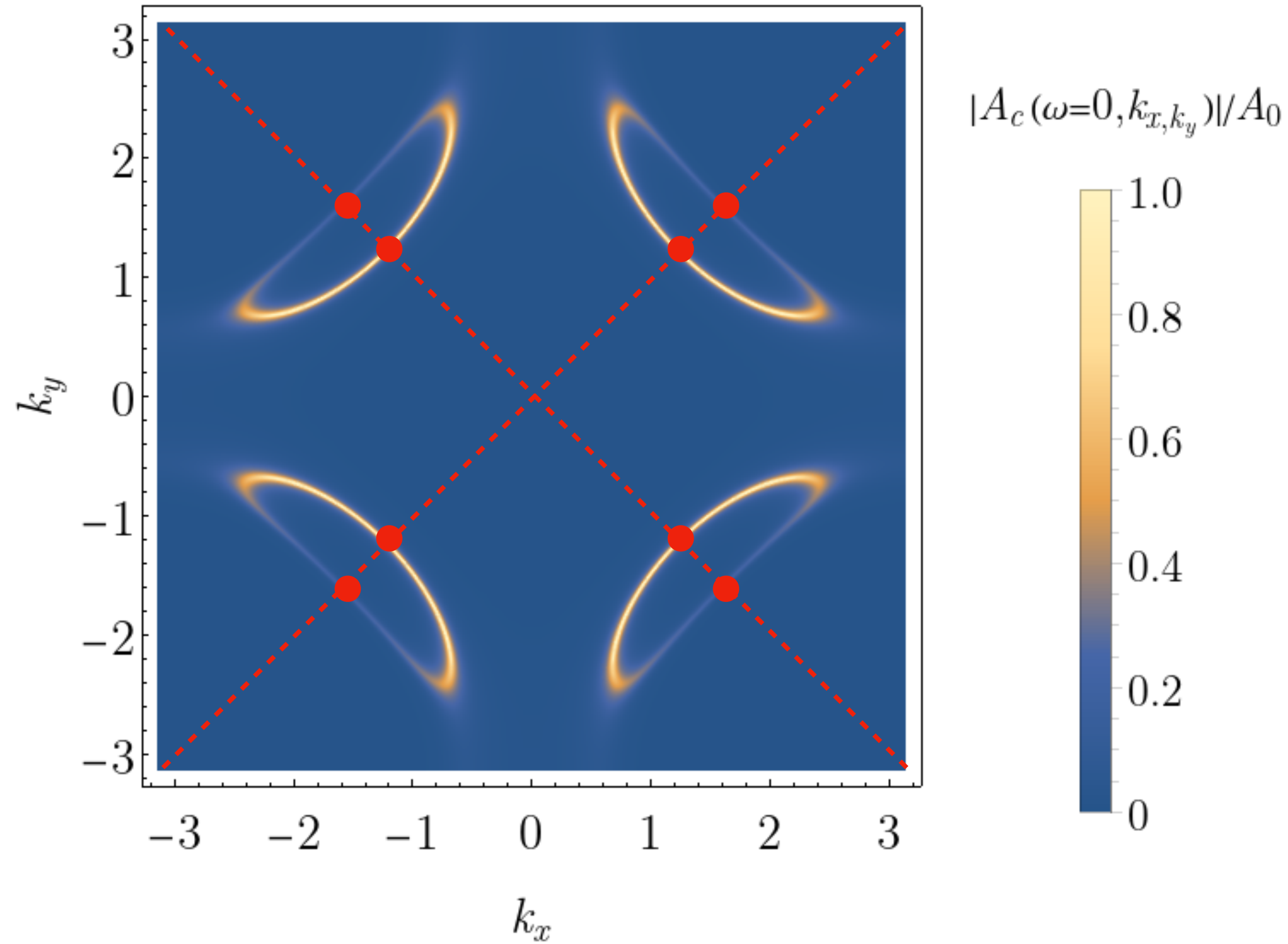

$$E_{\mathbf{k}} = (\varepsilon_{\mathbf{k}}^2 + \Delta_{\mathbf{k}}^2)^{1/2}$$

$$\Delta_{\mathbf{k}} = \Delta_0 (\cos k_x - \cos k_y)$$

Adding *d*-wave pairing
 to the hole pockets
 leads to 8 nodal points??

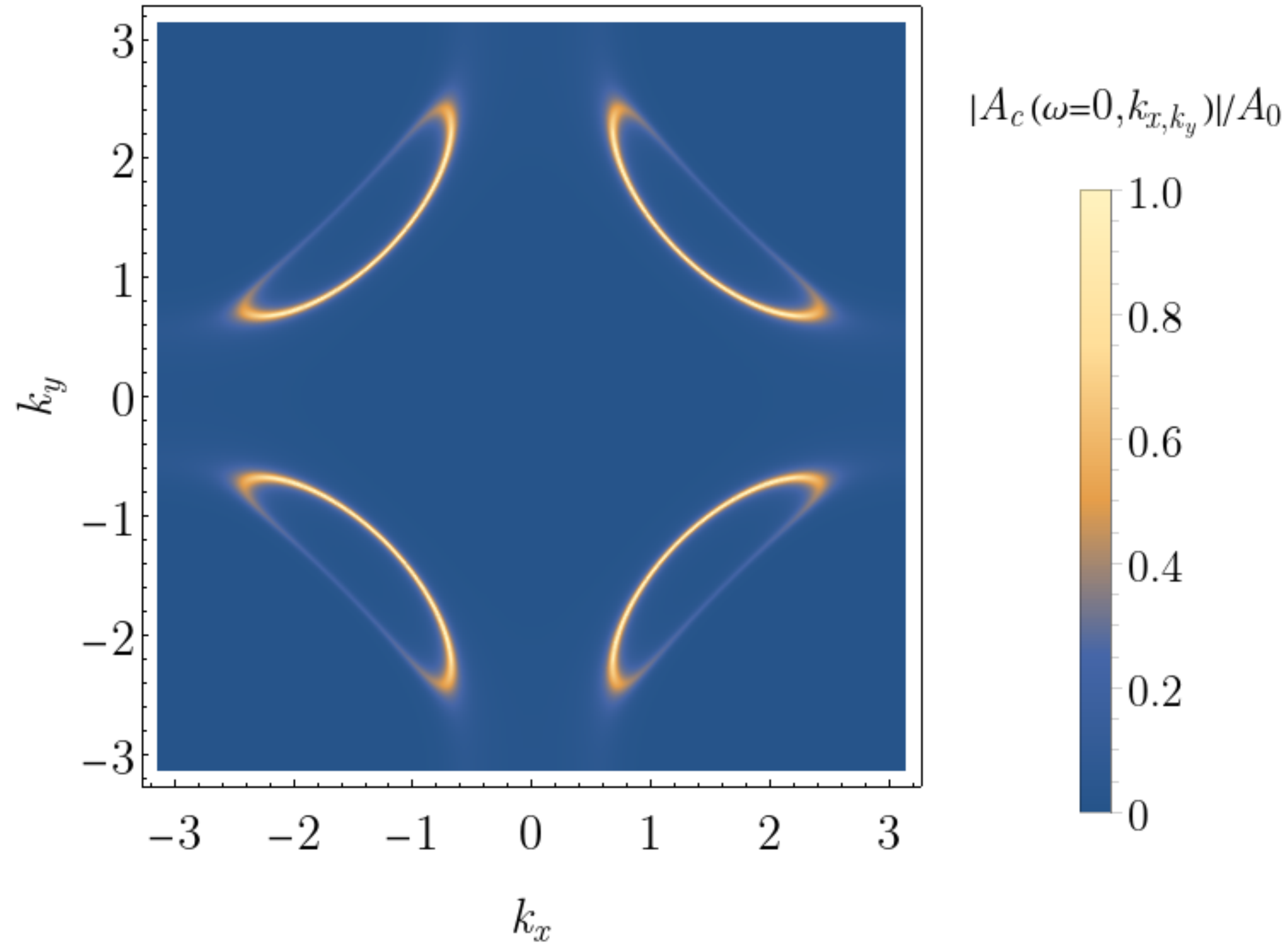

Hole pocket Fermi surfaces
 of size p with
 charge e , spin-1/2 quasiparticles
 +
 ‘spectator’
 square lattice spin liquid
at half-filling.

FL*: Spin liquid is *required* because
 the Fermi surface does not enclose
 the Luttinger volume $(1 + p)$.

From FL*

to

a cuprate phase diagram

The dance of electrons on Cu atoms in YBCO

P.W. Anderson (1973)

Spin liquid

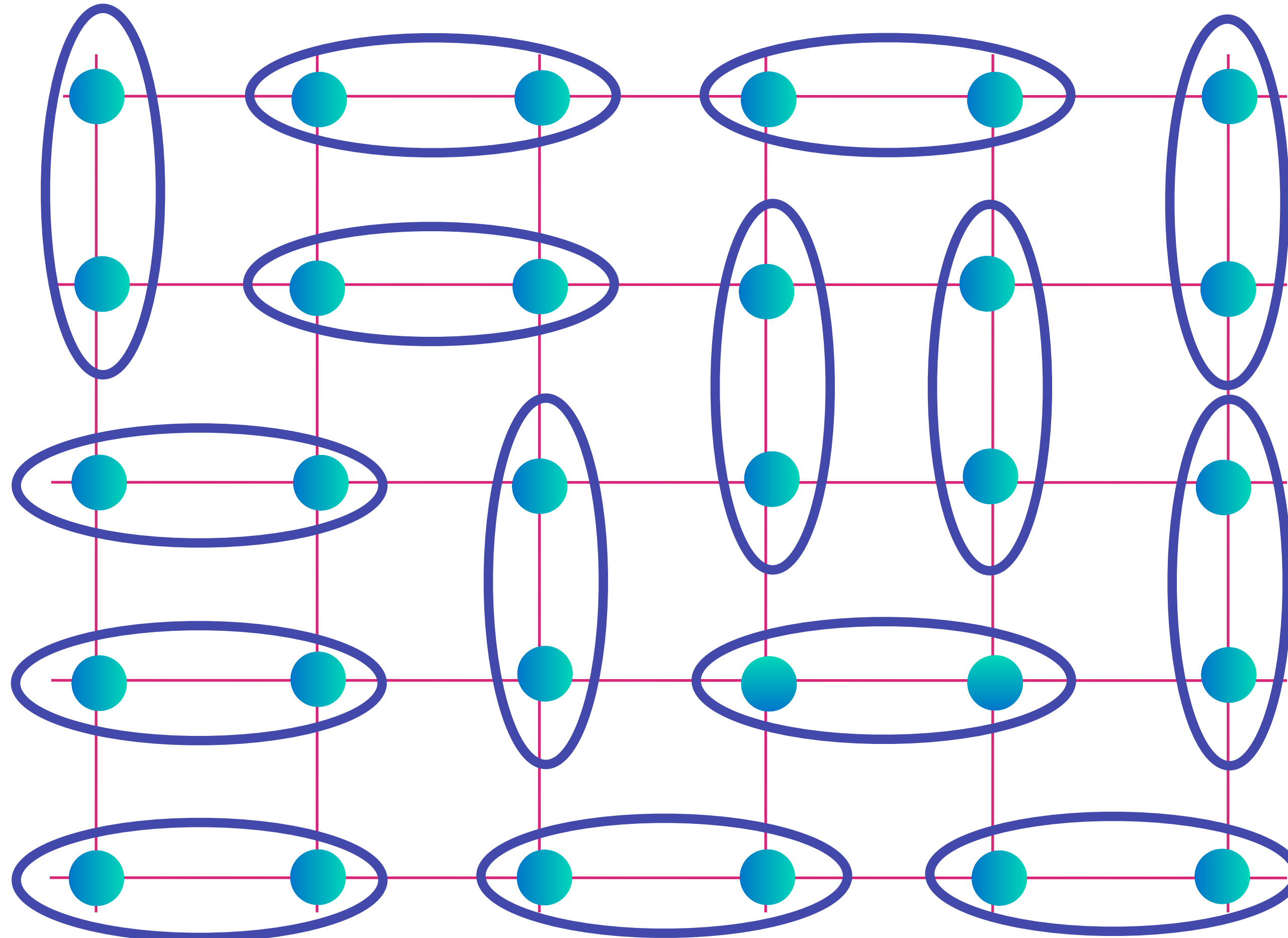

Electrons form entangled pairs, and the pairs entangle across the entire sample

$$\text{Diagram of two electrons in an oval} = |\uparrow\downarrow\rangle - |\downarrow\uparrow\rangle$$

G. Baskaran, Z. Zou, P.W. Anderson,
Solid State Comm. **63**, 973 (1987)
S.A. Kivelson, D.S. Rokhsar and J.P. Sethna,
Phys. Rev. B **35**, 8865 (1987)
D. Rokhsar and S.A. Kivelson,
Phys. Rev. Lett. **61**, 2376 (1988)
E. Fradkin and S.A. Kivelson,
Mod. Phys. Lett. B **4**, 225 (1990)

The dance of electrons on Cu atoms in YBCO

P.W. Anderson (1973)

Spin liquid

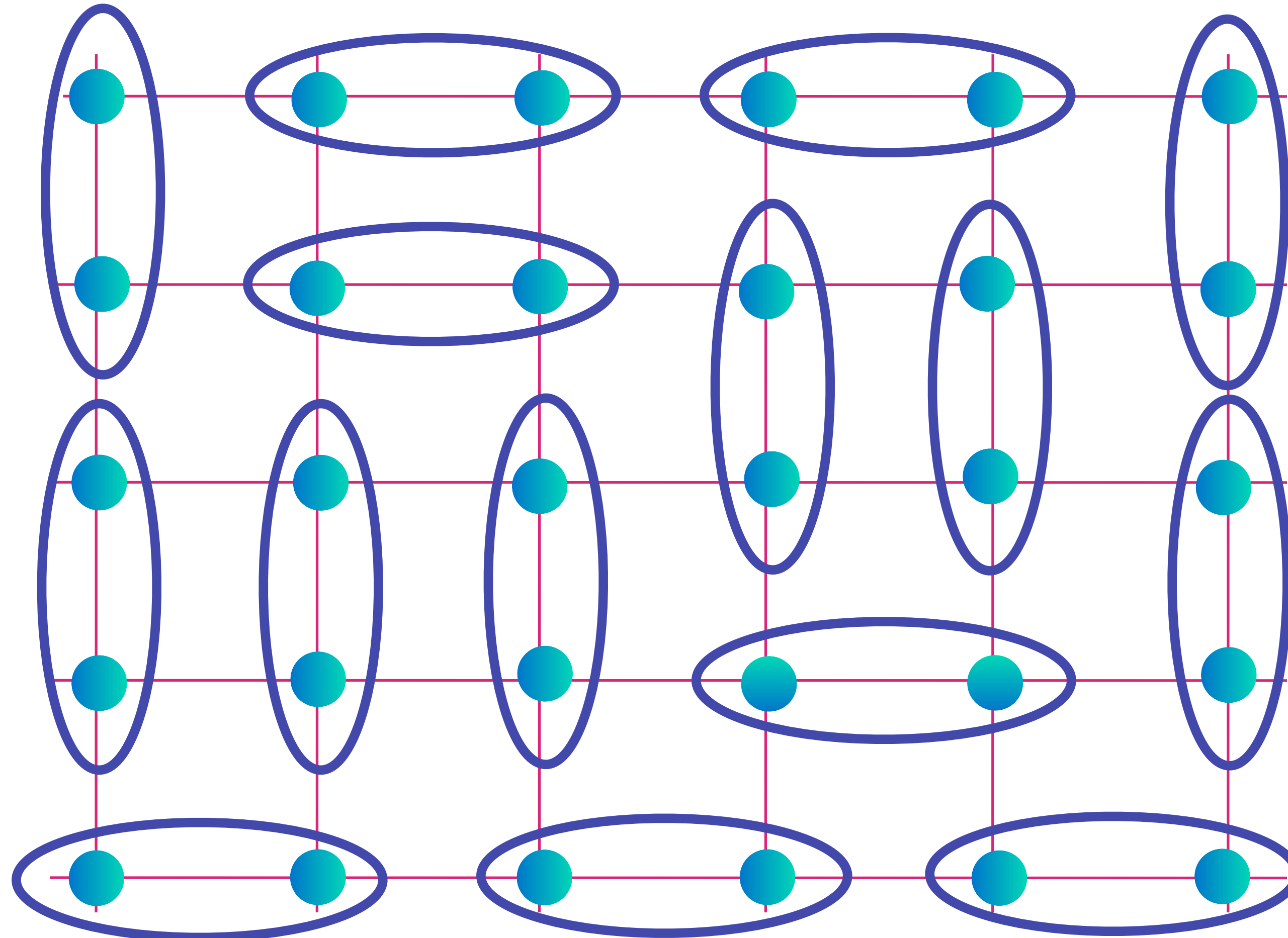

Electrons form entangled pairs, and the pairs entangle across the entire sample

$$\text{Diagram of two teal dots in a blue oval} = |\uparrow\downarrow\rangle - |\downarrow\uparrow\rangle$$

G. Baskaran, Z. Zou, P.W. Anderson,
Solid State Comm. **63**, 973 (1987)
S.A. Kivelson, D.S. Rokhsar and J.P. Sethna,
Phys. Rev. B **35**, 8865 (1987)
D. Rokhsar and S.A. Kivelson,
Phys. Rev. Lett. **61**, 2376 (1988)
E. Fradkin and S.A. Kivelson,
Mod. Phys. Lett. B **4**, 225 (1990)

The dance of electrons on Cu atoms in YBCO

P.W. Anderson (1973)

Spin liquid

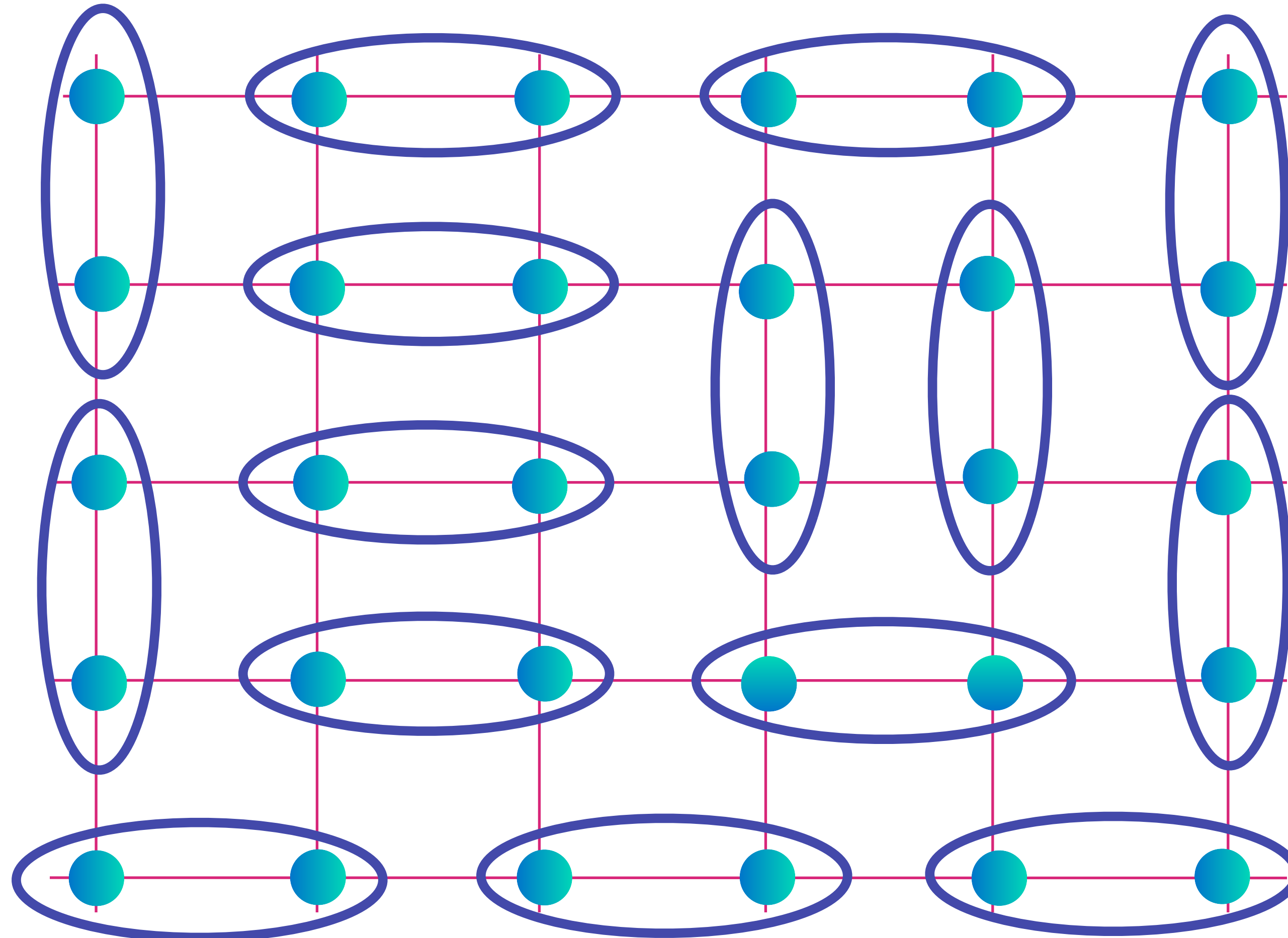

Electrons form entangled pairs, and the pairs entangle across the entire sample

$$\text{Diagram of two electrons in a pair} = |\uparrow\downarrow\rangle - |\downarrow\uparrow\rangle$$

- G. Baskaran, Z. Zou, P.W. Anderson,
Solid State Comm. **63**, 973 (1987)
S.A. Kivelson, D.S. Rokhsar and J.P. Sethna,
Phys. Rev. B **35**, 8865 (1987)
D. Rokhsar and S.A. Kivelson,
Phys. Rev. Lett. **61**, 2376 (1988)
E. Fradkin and S.A. Kivelson,
Mod. Phys. Lett. B **4**, 225 (1990)

The dance of electrons on Cu atoms in YBCO

P.W. Anderson (1973)

Spin liquid

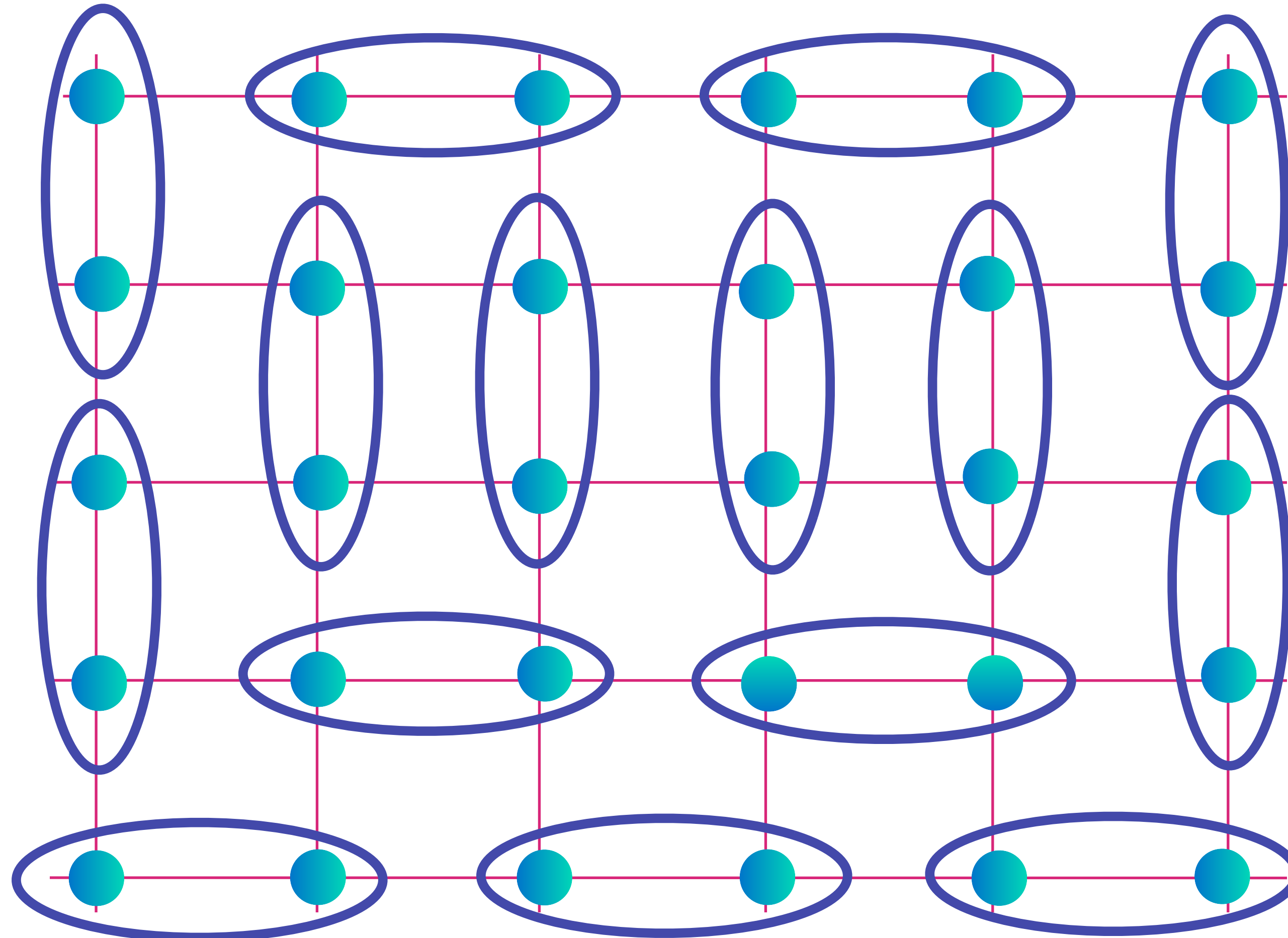

Electrons form entangled pairs, and the pairs entangle across the entire sample

$$\text{[Diagram of two electrons in a pair]} = |\uparrow\downarrow\rangle - |\downarrow\uparrow\rangle$$

G. Baskaran, Z. Zou, P.W. Anderson,
Solid State Comm. **63**, 973 (1987)
S.A. Kivelson, D.S. Rokhsar and J.P. Sethna,
Phys. Rev. B **35**, 8865 (1987)
D. Rokhsar and S.A. Kivelson,
Phys. Rev. Lett. **61**, 2376 (1988)
E. Fradkin and S.A. Kivelson,
Mod. Phys. Lett. B **4**, 225 (1990)

The dance of electrons on Cu atoms in YBCO

P.W. Anderson (1973)

Spin liquid

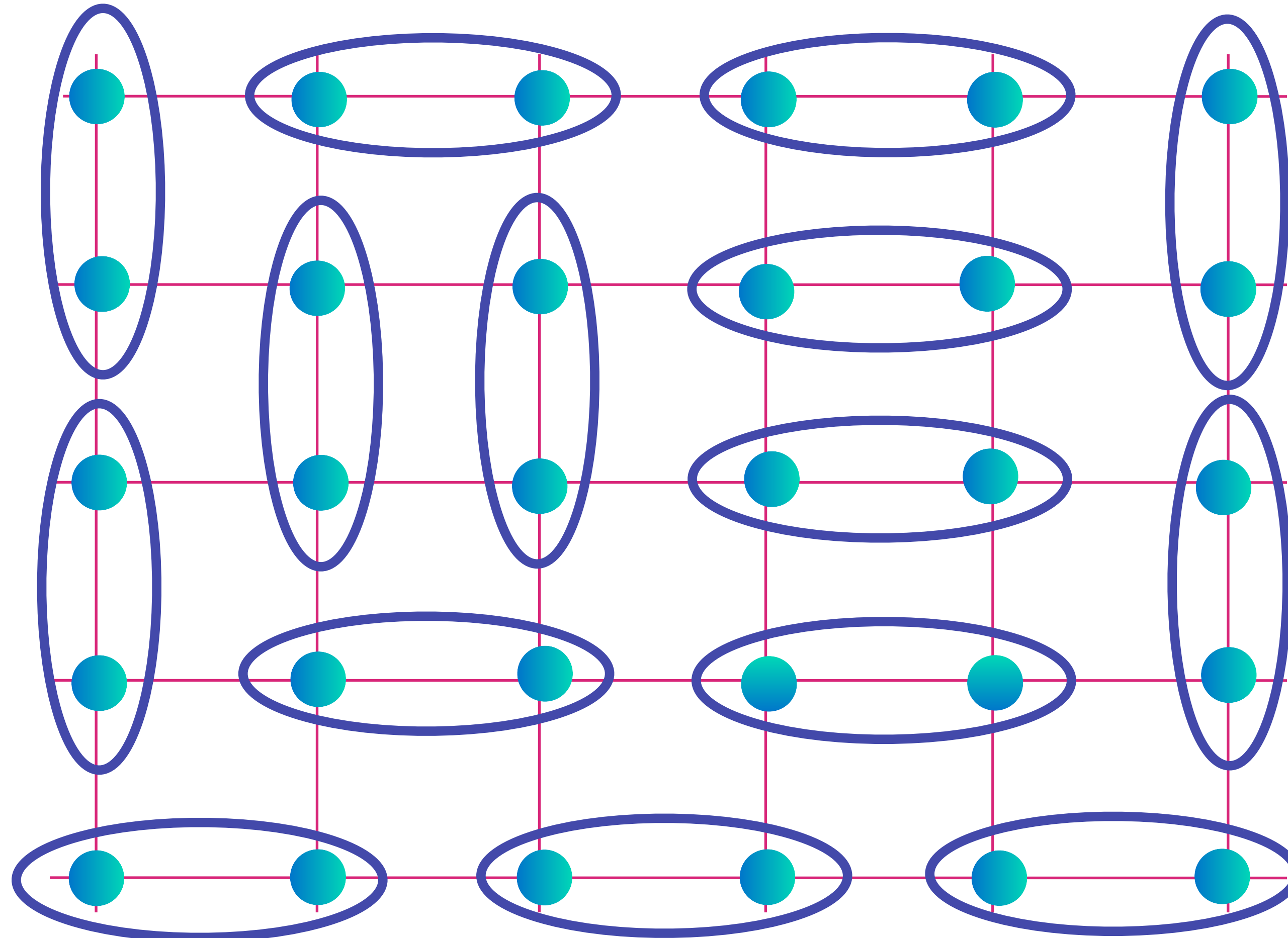

Electrons form entangled pairs, and the pairs entangle across the entire sample

$$\text{Diagram of two electrons in a pair} = |\uparrow\downarrow\rangle - |\downarrow\uparrow\rangle$$

- G. Baskaran, Z. Zou, P.W. Anderson,
Solid State Comm. **63**, 973 (1987)
S.A. Kivelson, D.S. Rokhsar and J.P. Sethna,
Phys. Rev. B **35**, 8865 (1987)
D. Rokhsar and S.A. Kivelson,
Phys. Rev. Lett. **61**, 2376 (1988)
E. Fradkin and S.A. Kivelson,
Mod. Phys. Lett. B **4**, 225 (1990)

The dance of electrons on Cu atoms in YBCO

P.W. Anderson (1973)

Spin liquid

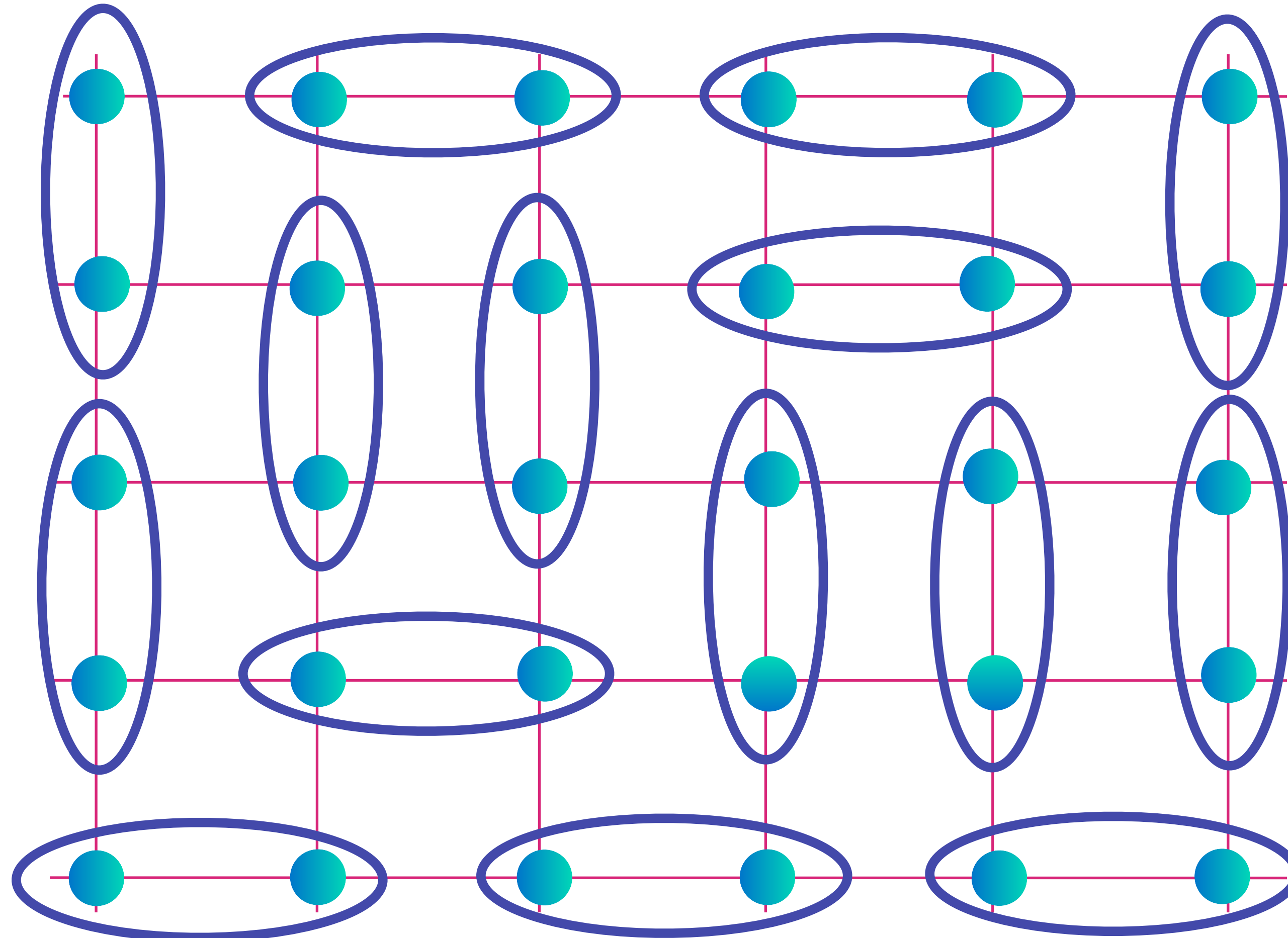

Electrons form entangled pairs, and the pairs entangle across the entire sample

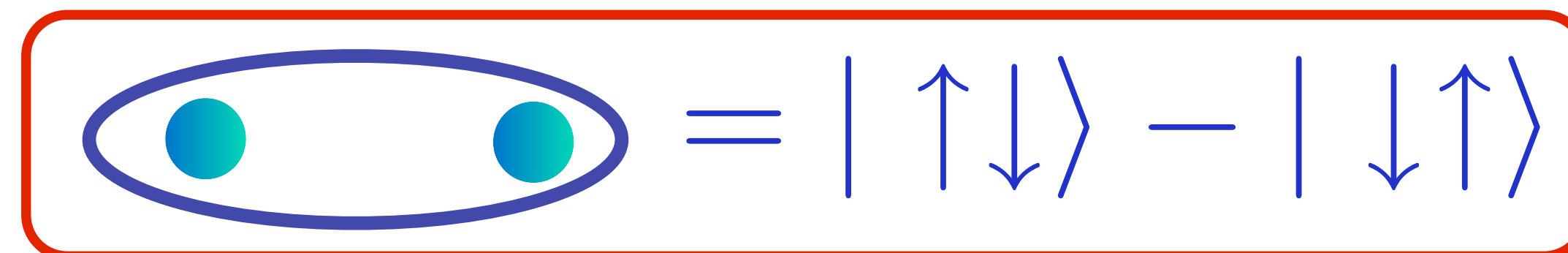

G. Baskaran, Z. Zou, P.W. Anderson,
Solid State Comm. **63**, 973 (1987)
S.A. Kivelson, D.S. Rokhsar and J.P. Sethna,
Phys. Rev. B **35**, 8865 (1987)
D. Rokhsar and S.A. Kivelson,
Phys. Rev. Lett. **61**, 2376 (1988)
E. Fradkin and S.A. Kivelson,
Mod. Phys. Lett. B **4**, 225 (1990)

The dance of electrons on Cu atoms in YBCO

P.W. Anderson (1973)

Spin liquid

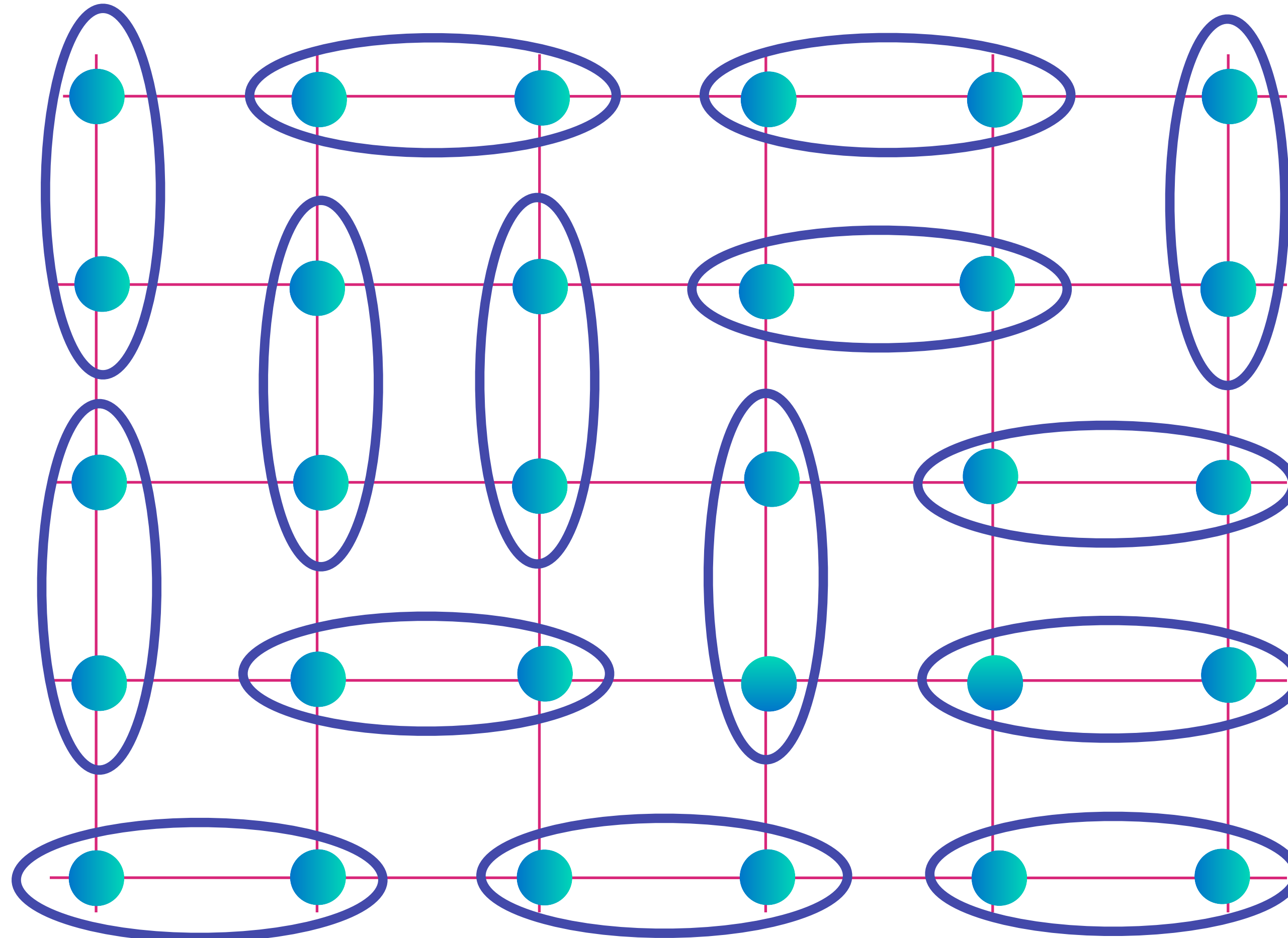

Electrons form entangled pairs, and the pairs entangle across the entire sample

$$\text{[Diagram of two cyan dots in a blue oval]} = |\uparrow\downarrow\rangle - |\downarrow\uparrow\rangle$$

- G. Baskaran, Z. Zou, P.W. Anderson, *Solid State Comm.* **63**, 973 (1987)
S.A. Kivelson, D.S. Rokhsar and J.P. Sethna, *Phys. Rev. B* **35**, 8865 (1987)
D. Rokhsar and S.A. Kivelson, *Phys. Rev. Lett.* **61**, 2376 (1988)
E. Fradkin and S.A. Kivelson, *Mod. Phys. Lett. B* **4**, 225 (1990)

The dance of electrons on Cu atoms in YBCO

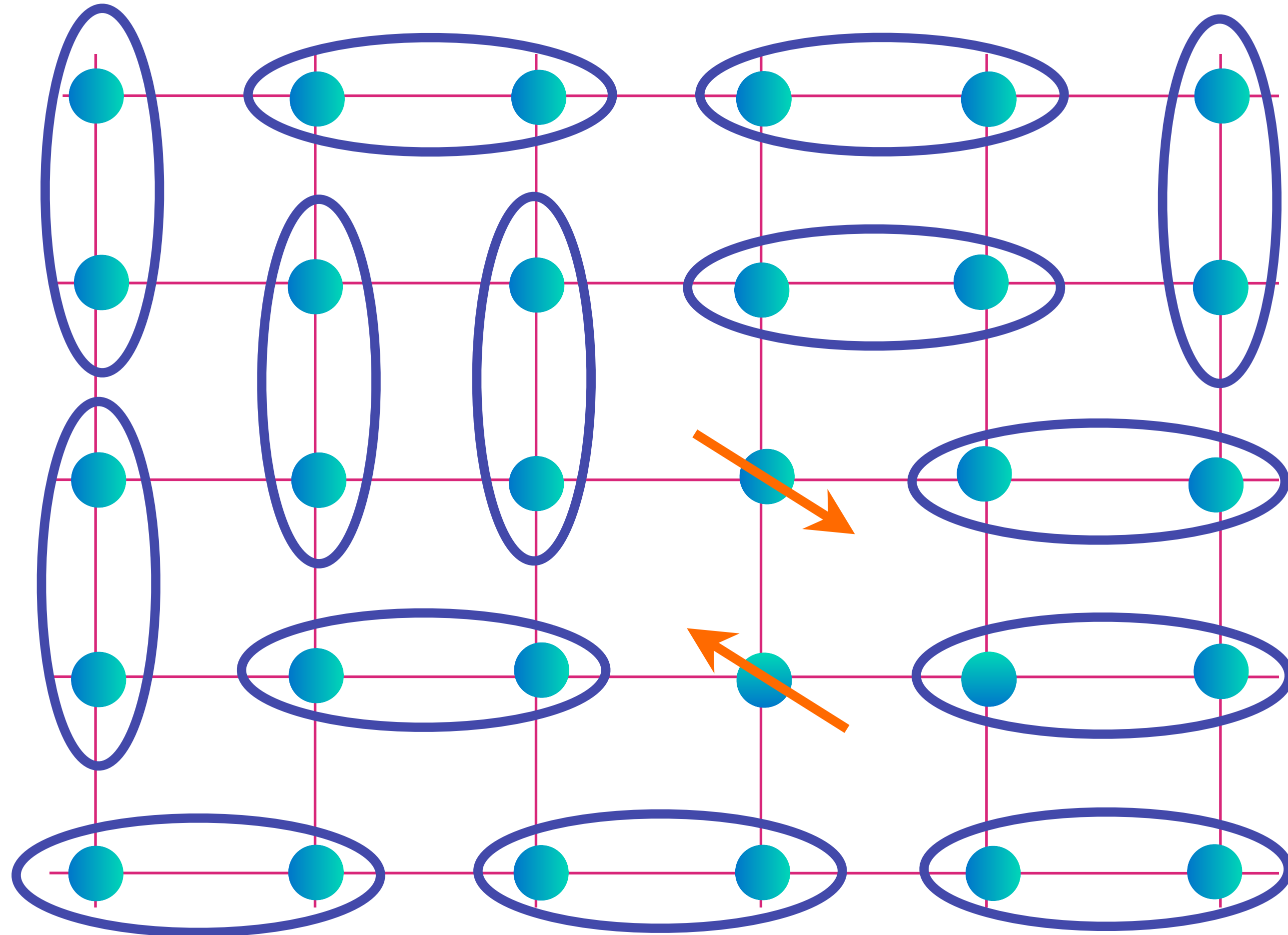

Spin liquid

Fractionalized
spinon
excitations
with spin $S=1/2$
and charge 0.

$$\text{Cyan dot in blue oval} = |\uparrow\downarrow\rangle - |\downarrow\uparrow\rangle$$

- G. Baskaran, Z. Zou, P.W. Anderson,
Solid State Comm. **63**, 973 (1987)
S.A. Kivelson, D.S. Rokhsar and J.P. Sethna,
Phys. Rev. B **35**, 8865 (1987)
D. Rokhsar and S.A. Kivelson,
Phys. Rev. Lett. **61**, 2376 (1988)
E. Fradkin and S.A. Kivelson,
Mod. Phys. Lett. B **4**, 225 (1990)

The dance of electrons on Cu atoms in YBCO

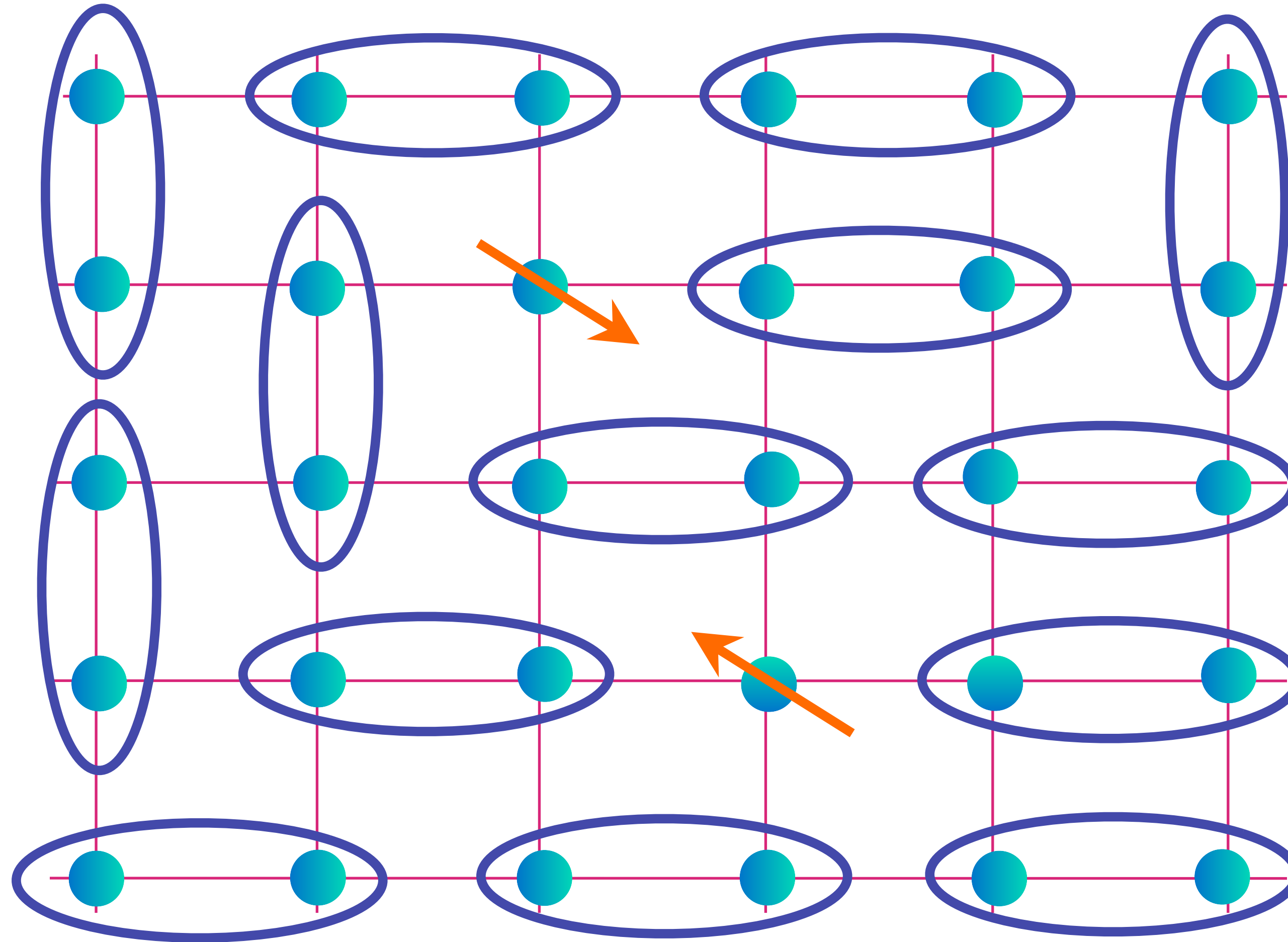

Spin liquid

Fractionalized spinon excitations with spin $S=1/2$ and charge 0.

$$\text{Oval with two electrons} = |\uparrow\downarrow\rangle - |\downarrow\uparrow\rangle$$

G. Baskaran, Z. Zou, P.W. Anderson, *Solid State Comm.* **63**, 973 (1987)
 S.A. Kivelson, D.S. Rokhsar and J.P. Sethna, *Phys. Rev. B* **35**, 8865 (1987)
 D. Rokhsar and S.A. Kivelson, *Phys. Rev. Lett.* **61**, 2376 (1988)
 E. Fradkin and S.A. Kivelson, *Mod. Phys. Lett. B* **4**, 225 (1990)

The dance of electrons on Cu atoms in YBCO

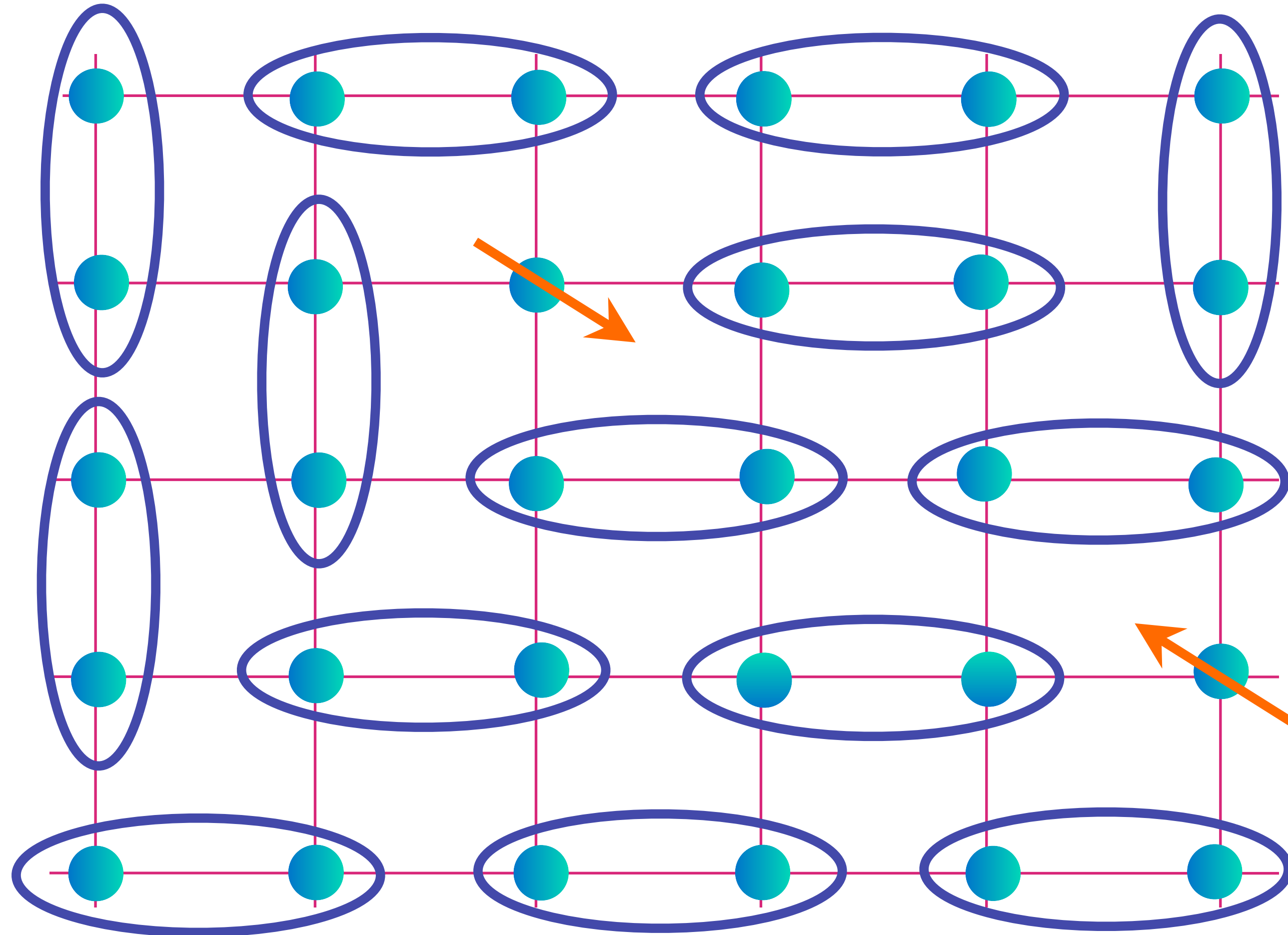

Spin liquid

Fractionalized
spinon
excitations
with spin $S=1/2$
and charge 0.

$$\text{[Diagram of two electrons in a blue oval]} = |\uparrow\downarrow\rangle - |\downarrow\uparrow\rangle$$

- G. Baskaran, Z. Zou, P.W. Anderson,
Solid State Comm. **63**, 973 (1987)
S.A. Kivelson, D.S. Rokhsar and J.P. Sethna,
Phys. Rev. B **35**, 8865 (1987)
D. Rokhsar and S.A. Kivelson,
Phys. Rev. Lett. **61**, 2376 (1988)
E. Fradkin and S.A. Kivelson,
Mod. Phys. Lett. B **4**, 225 (1990)

The dance of electrons on Cu atoms in YBCO

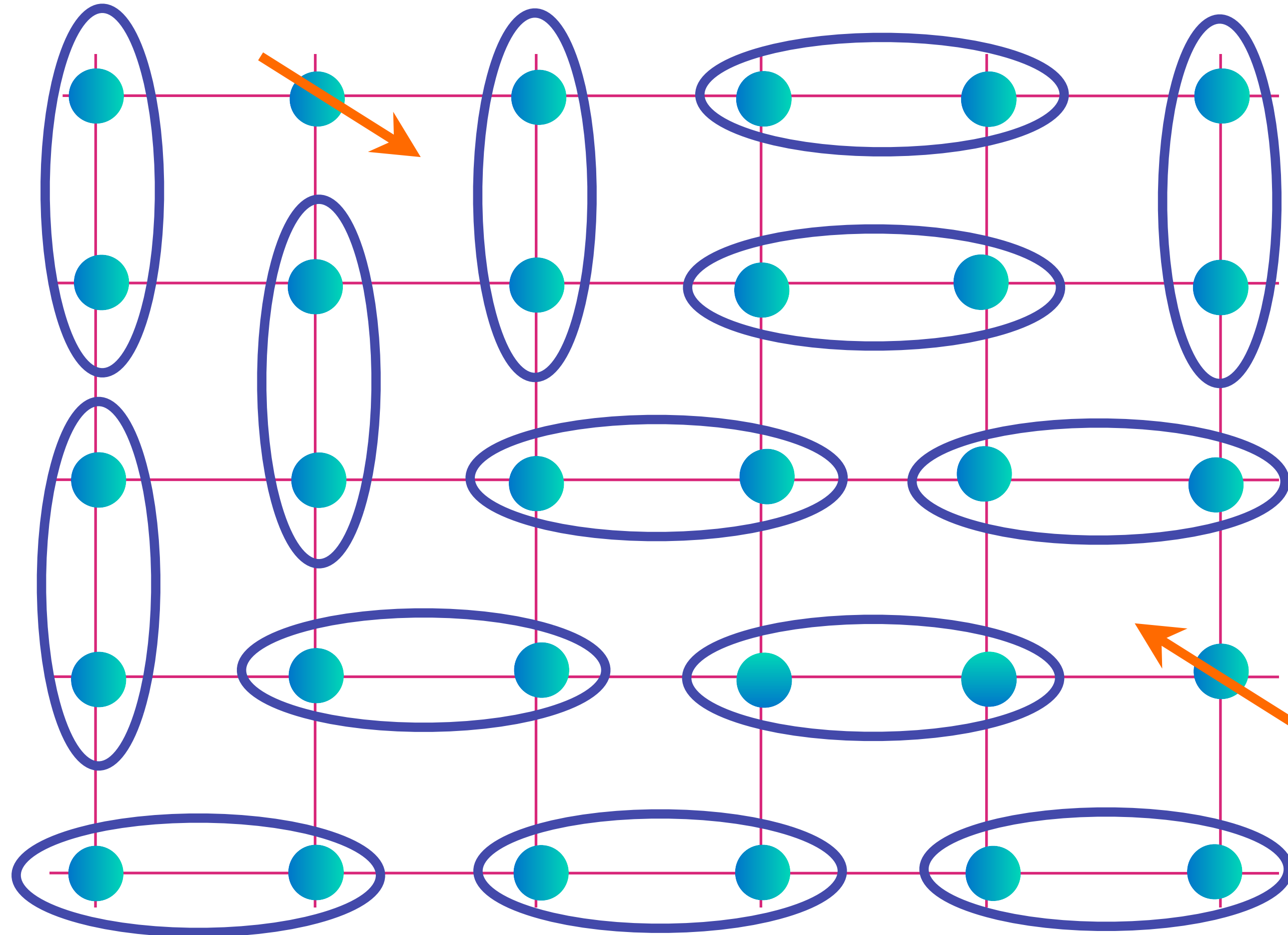

Spin liquid

Fractionalized
spinon
excitations
with spin $S=1/2$
and charge 0.

$$\text{Diagram of two electrons in a pair} = |\uparrow\downarrow\rangle - |\downarrow\uparrow\rangle$$

- G. Baskaran, Z. Zou, P.W. Anderson,
Solid State Comm. **63**, 973 (1987)
S.A. Kivelson, D.S. Rokhsar and J.P. Sethna,
Phys. Rev. B **35**, 8865 (1987)
D. Rokhsar and S.A. Kivelson,
Phys. Rev. Lett. **61**, 2376 (1988)
E. Fradkin and S.A. Kivelson,
Mod. Phys. Lett. B **4**, 225 (1990)

Holons

G. Baskaran, Z. Zou, P.W. Anderson, *Solid State Comm.* **63**, 973 (1987)

S.A. Kivelson, D.S. Rokhsar and J.P. Sethna, *Phys. Rev. B* **35**, 8865 (1987)

D. Rokhsar and S.A. Kivelson, *Phys. Rev. Lett.* **61**, 2376 (1988)

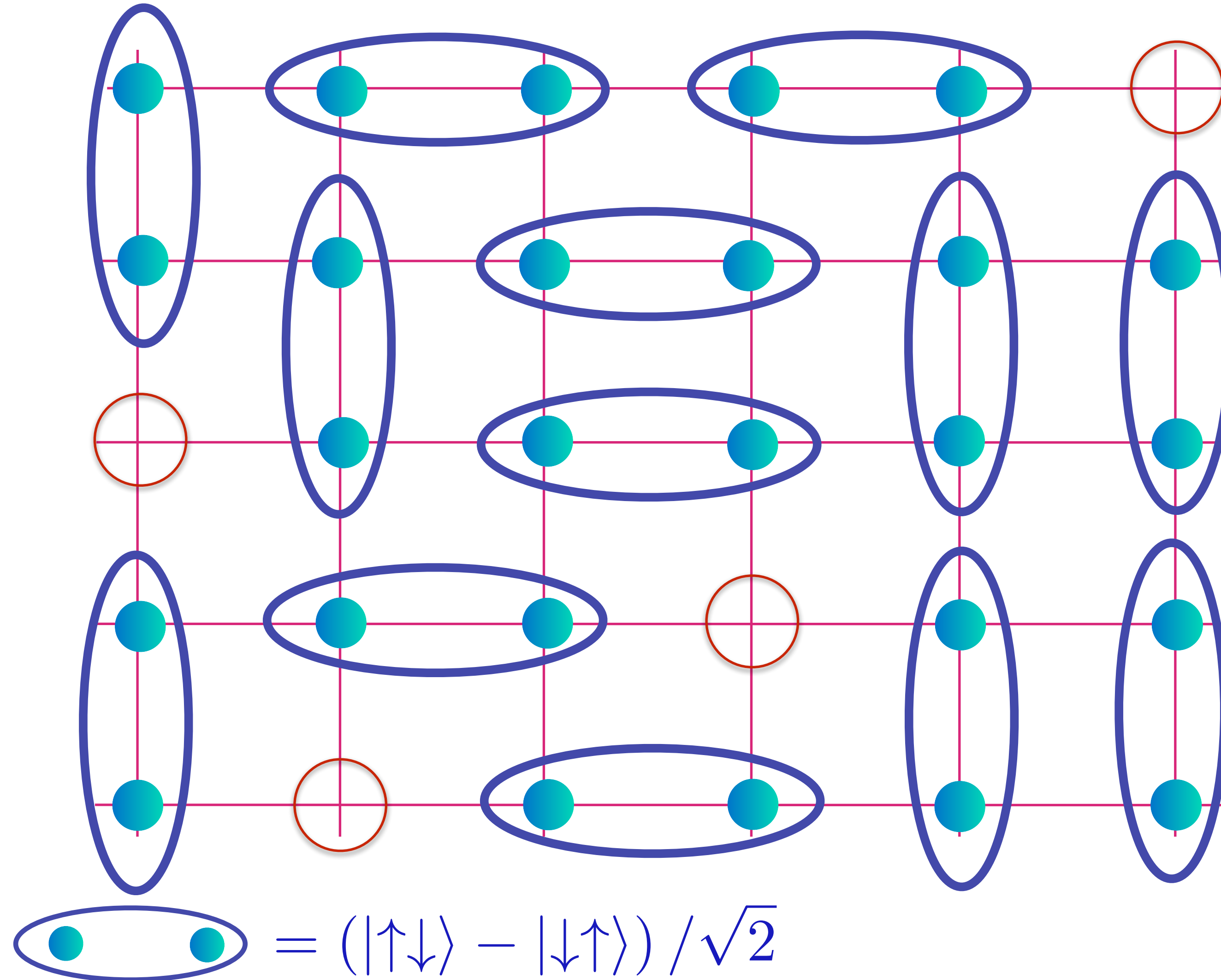

Spin liquid

Fractionalized
holon excitations
with spin $S=0$
and charge $+e$.

Holons

G. Baskaran, Z. Zou, P.W. Anderson, *Solid State Comm.* **63**, 973 (1987)

S.A. Kivelson, D.S. Rokhsar and J.P. Sethna, *Phys. Rev. B* **35**, 8865 (1987)

D. Rokhsar and S.A. Kivelson, *Phys. Rev. Lett.* **61**, 2376 (1988)

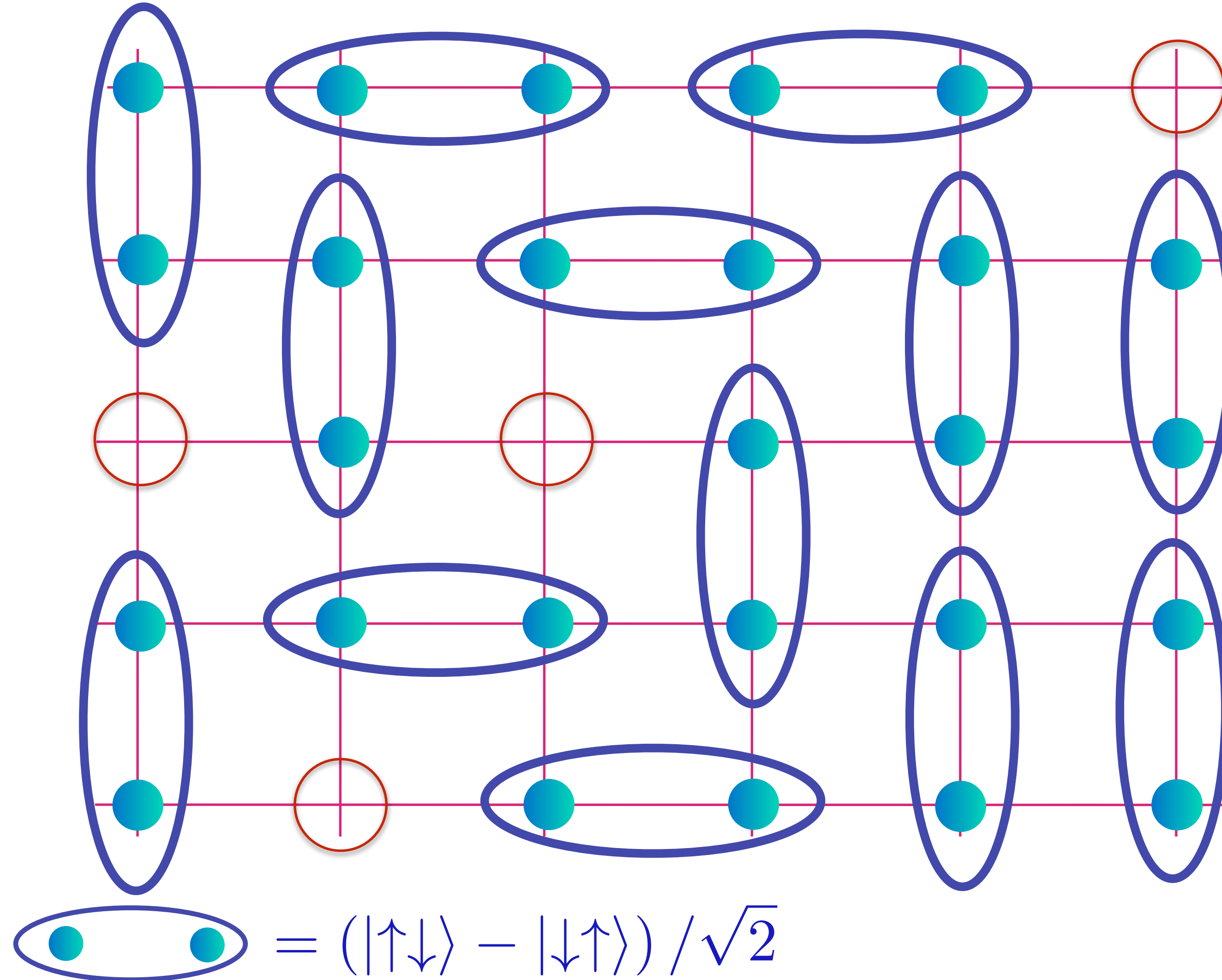

Spin liquid

Fractionalized
holon excitations
with spin $S=0$
and charge $+e$.

Holon metal

G. Baskaran, Z. Zou, P.W. Anderson, *Solid State Comm.* **63**, 973 (1987)

S.A. Kivelson, D.S. Rokhsar and J.P. Sethna, *Phys. Rev. B* **35**, 8865 (1987)

D. Rokhsar and S.A. Kivelson, *Phys. Rev. Lett.* **61**, 2376 (1988)

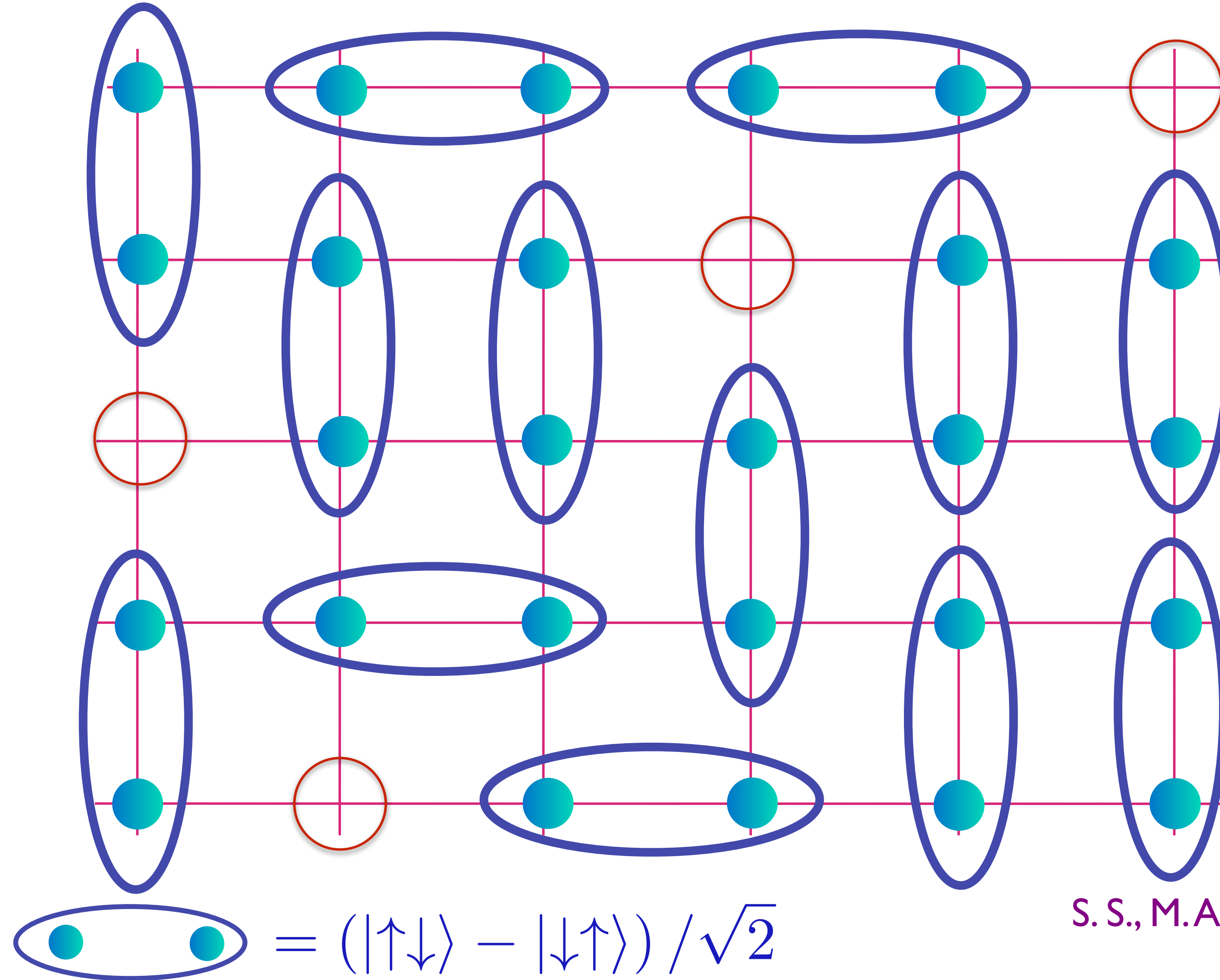

If each holon is a fermion, we obtain a Fermi surface of holons of size p

S. S., M.A. Metlitski, Y. Qi, and C. Xu, *PRB* **80**, 155129 (2009)

M. S. Scheurer, S. Chatterjee, Wei Wu, M. Ferrero,

A. Georges, and S. S., *PNAS* **115**, E3665 (2018)

Pietro M. Bonetti and Walter Metzner, *PRB* **106**, 205152 (2022)

Holon metal

G. Baskaran, Z. Zou, P.W. Anderson, *Solid State Comm.* **63**, 973 (1987)

S.A. Kivelson, D.S. Rokhsar and J.P. Sethna, *Phys. Rev. B* **35**, 8865 (1987)

D. Rokhsar and S.A. Kivelson, *Phys. Rev. Lett.* **61**, 2376 (1988)

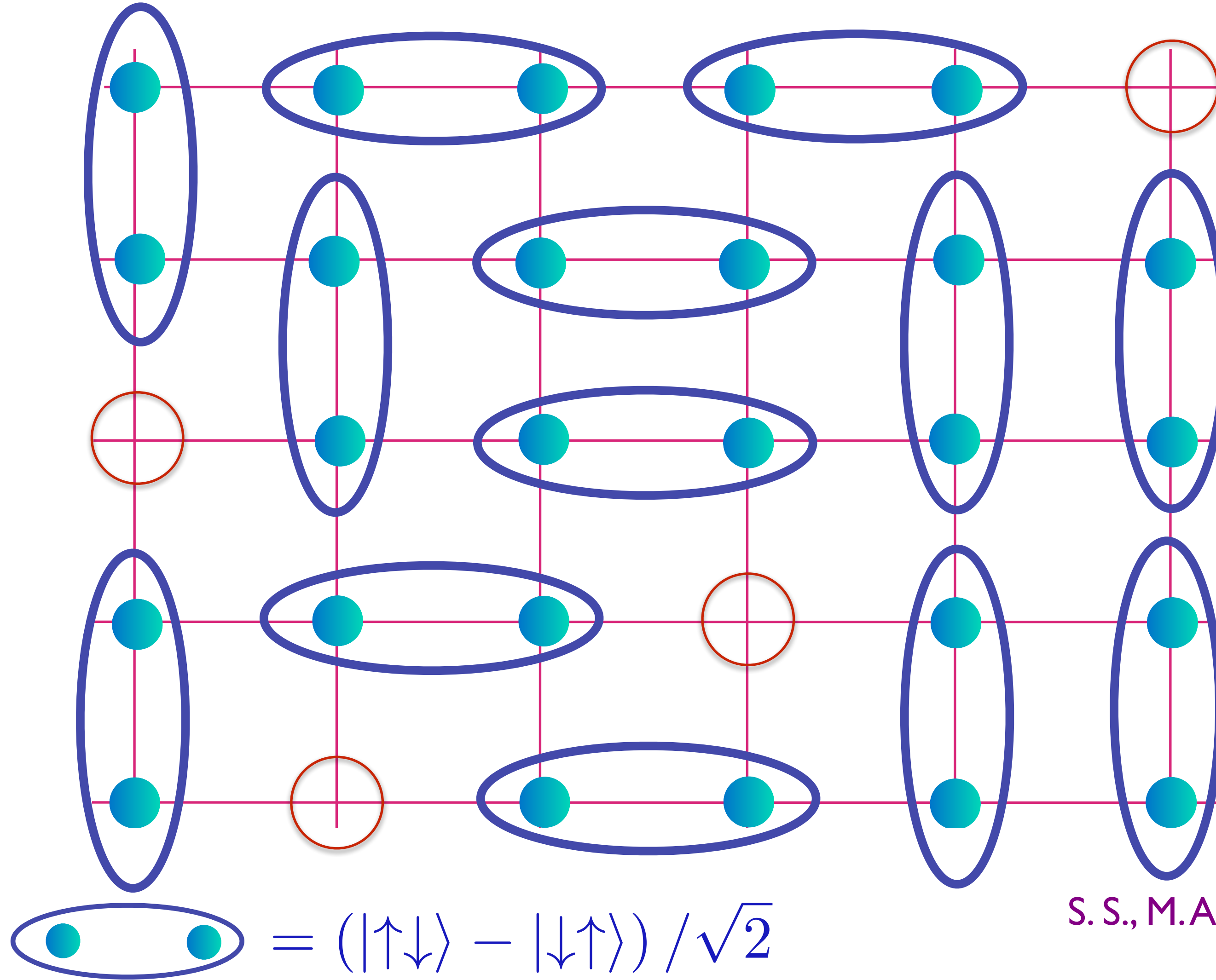

If each holon is a fermion, we obtain a Fermi surface of holons of size p

S. S., M.A. Metlitski, Y. Qi, and C. Xu, *PRB* **80**, 155129 (2009)

M. S. Scheurer, S. Chatterjee, Wei Wu, M. Ferrero,

A. Georges, and S. S., *PNAS* **115**, E3665 (2018)

Pietro M. Bonetti and Walter Metzner, *PRB* **106**, 205152 (2022)

FL* in a **one-band** model

S. Sachdev *Phys. Rev. B* **49**, 6770 (1994); X.-G. Wen and P.A. Lee *Phys. Rev. Lett.* **76**, 503 (1996)

R. K. Kaul, A. Kolezhuk, M. Levin, S. Sachdev, and T. Senthil, *Phys. Rev. B* **75**, 235122 (2007)

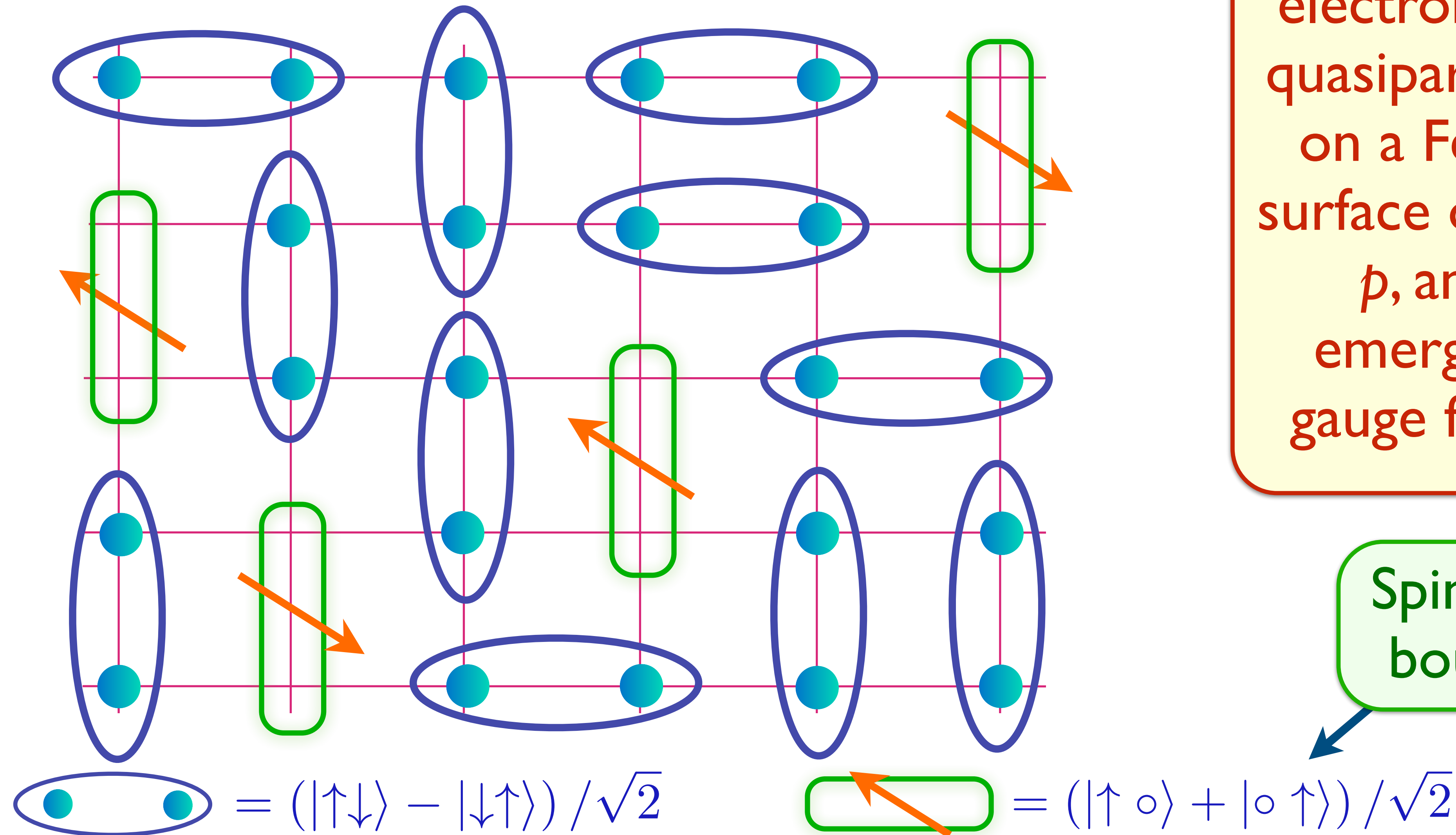

Metal with electron-like quasiparticles on a Fermi surface of size p , and emergent gauge fields

Spinon-holon bound state

FL* in a **one-band** model

S. Sachdev *Phys. Rev. B* **49**, 6770 (1994); X.-G. Wen and P.A. Lee *Phys. Rev. Lett.* **76**, 503 (1996)

R. K. Kaul, A. Kolezhuk, M. Levin, S. Sachdev, and T. Senthil, *Phys. Rev. B* **75**, 235122 (2007)

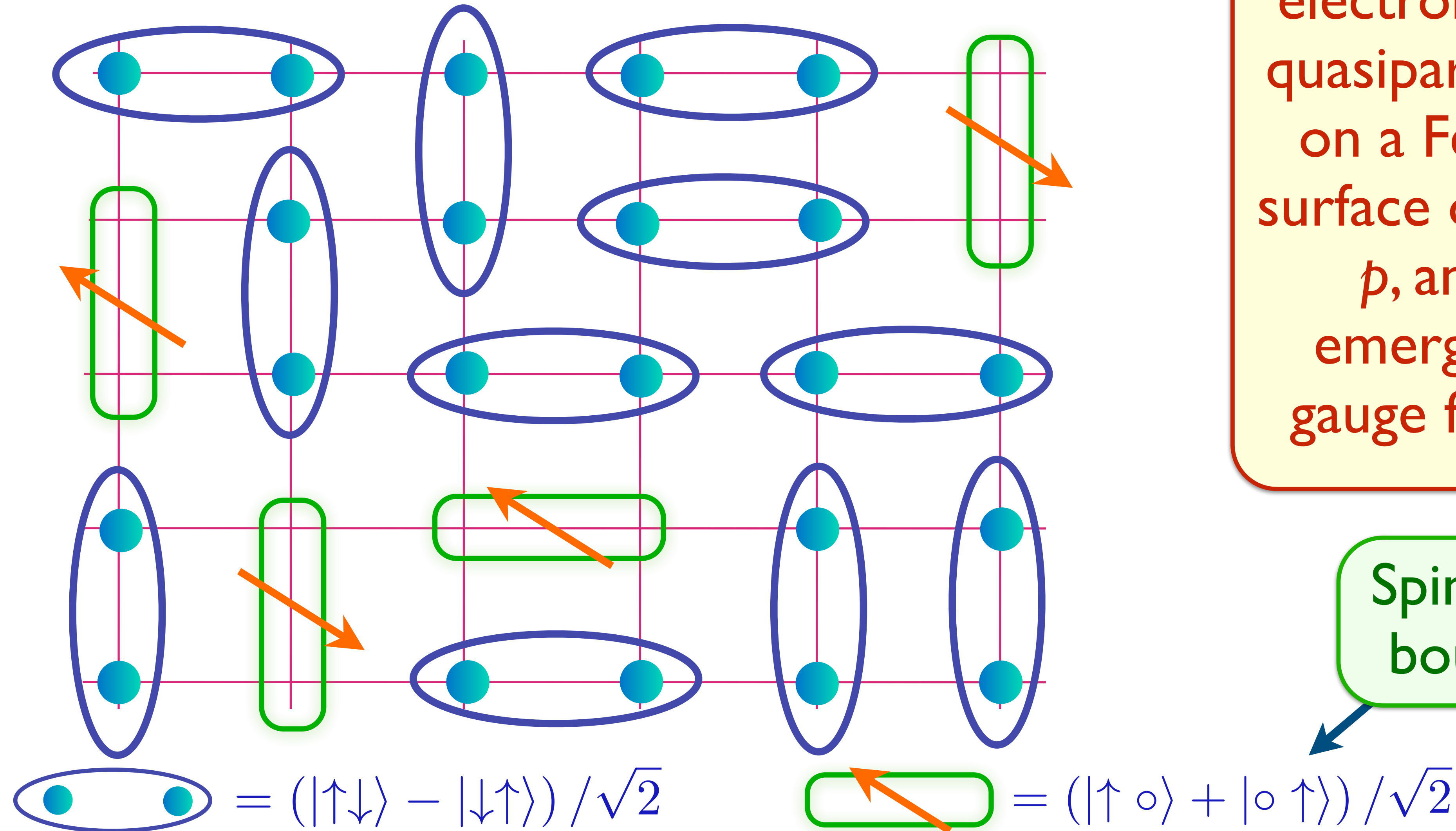

Metal with electron-like quasiparticles on a Fermi surface of size p , and emergent gauge fields

Spinon-holon bound state

FL* in a **one-band** model

S. Sachdev *Phys. Rev. B* **49**, 6770 (1994); X.-G. Wen and P.A. Lee *Phys. Rev. Lett.* **76**, 503 (1996)

R. K. Kaul, A. Kolezhuk, M. Levin, S. Sachdev, and T. Senthil, *Phys. Rev. B* **75**, 235122 (2007)

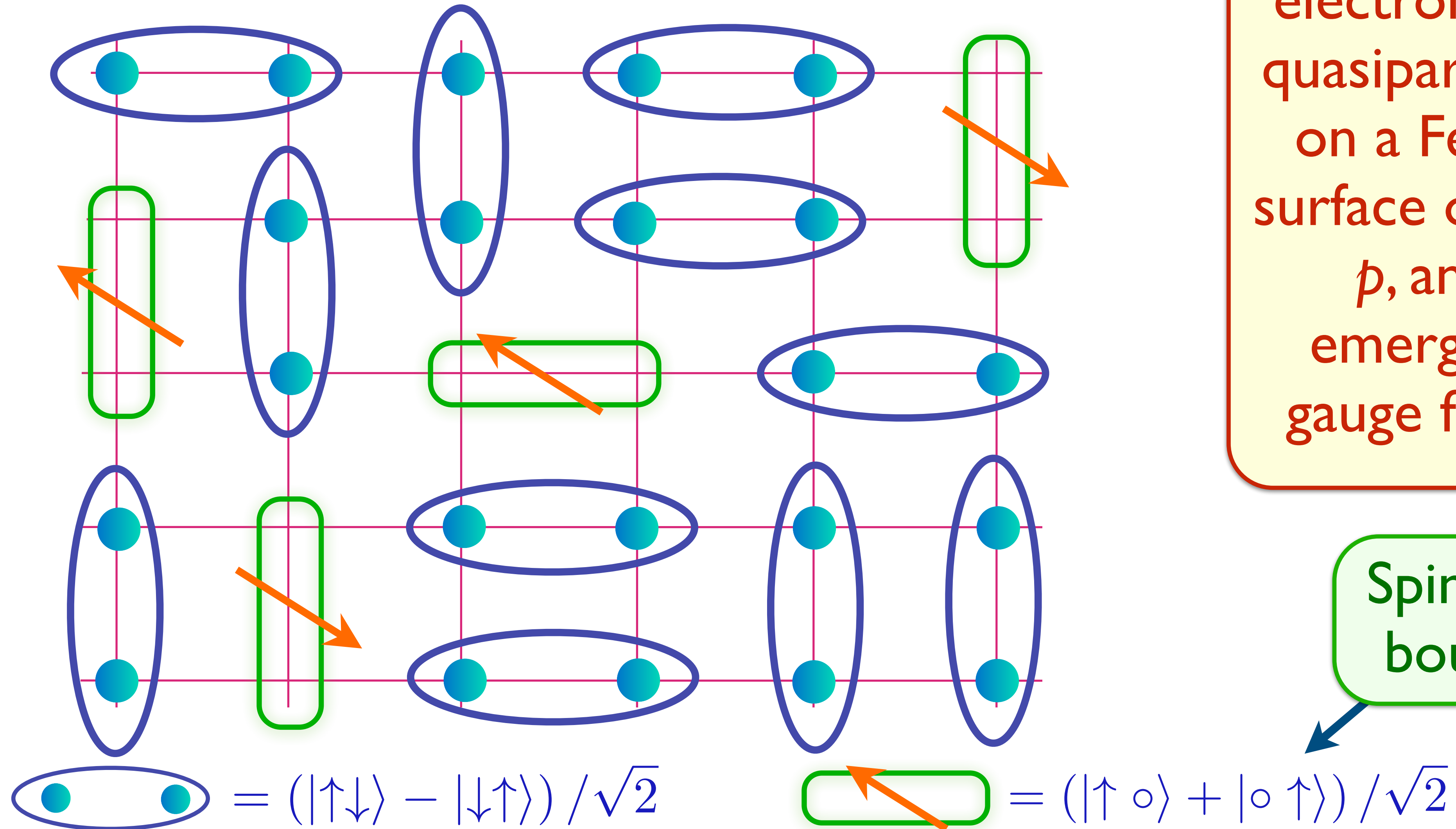

Metal with electron-like quasiparticles on a Fermi surface of size p , and emergent gauge fields

Spinon-holon bound state

FL* in a **one-band** model

S. Sachdev *Phys. Rev. B* **49**, 6770 (1994); X.-G. Wen and P.A. Lee *Phys. Rev. Lett.* **76**, 503 (1996)

R. K. Kaul, A. Kolezhuk, M. Levin, S. Sachdev, and T. Senthil, *Phys. Rev. B* **75**, 235122 (2007)

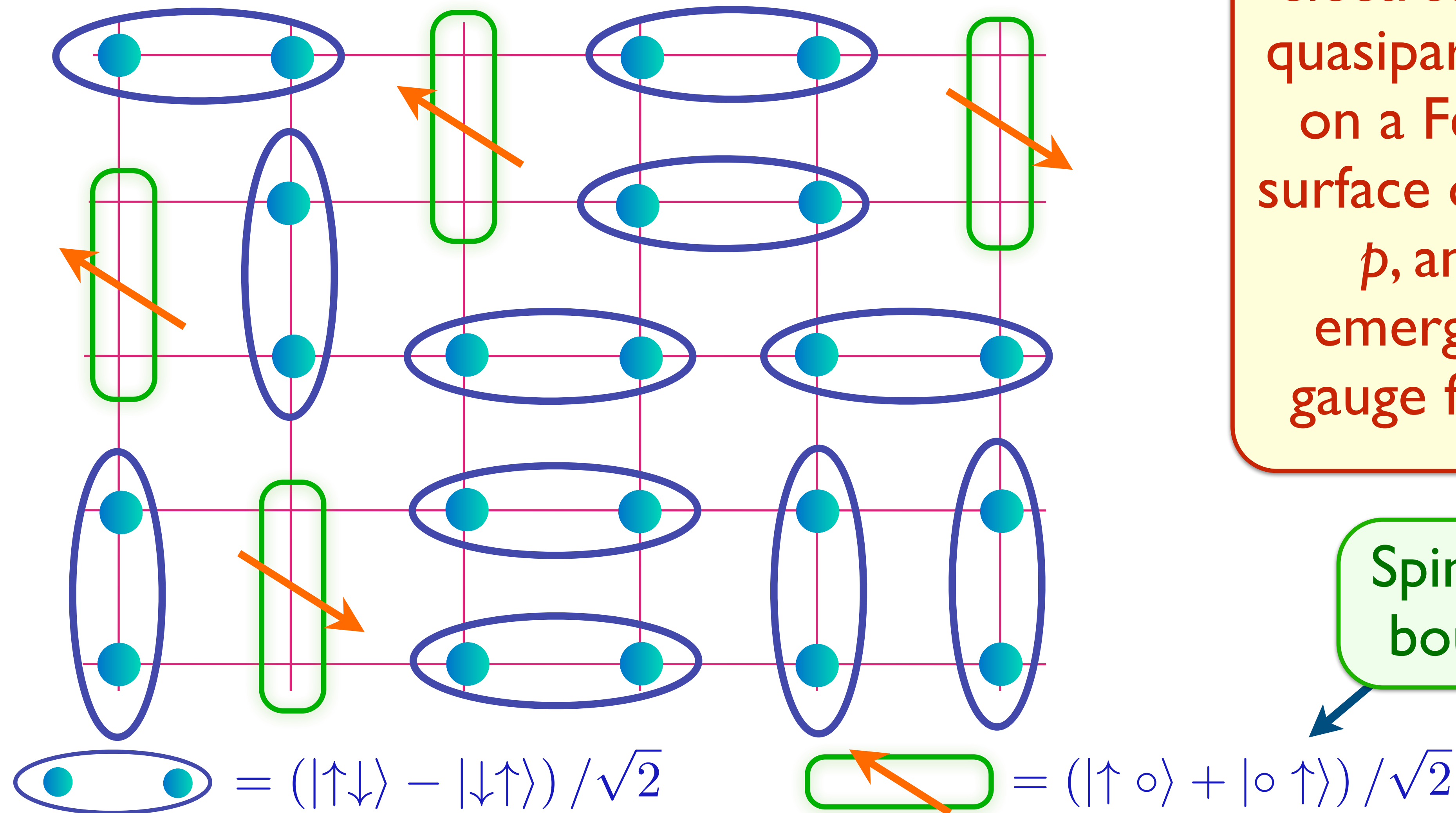

Metal with electron-like quasiparticles on a Fermi surface of size p , and emergent gauge fields

Spinon-holon bound state

FL* in a **one-band** model

S. Sachdev *Phys. Rev. B* **49**, 6770 (1994); X.-G. Wen and P.A. Lee *Phys. Rev. Lett.* **76**, 503 (1996)

R. K. Kaul, A. Kolezhuk, M. Levin, S. Sachdev, and T. Senthil, *Phys. Rev. B* **75**, 235122 (2007)

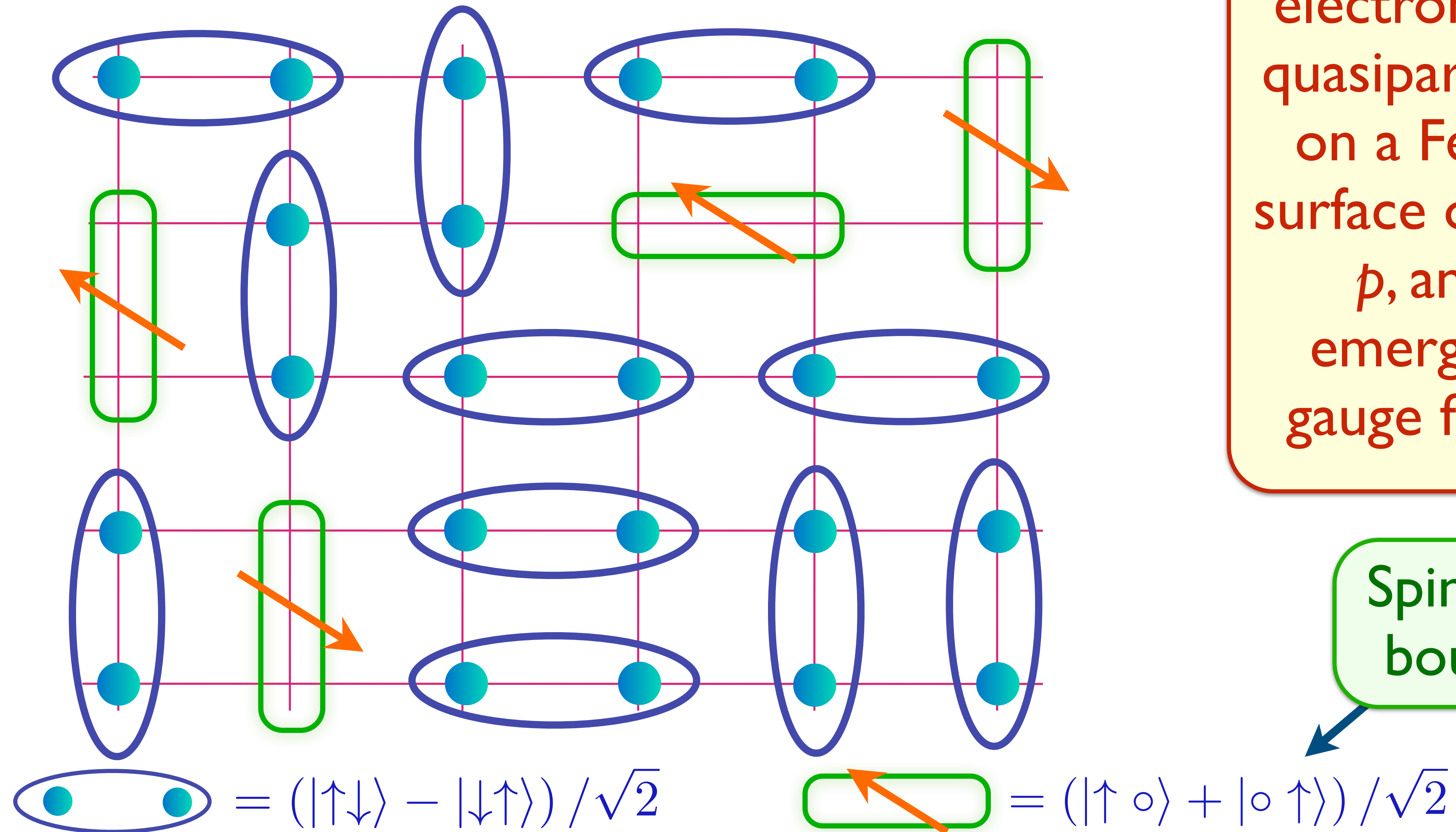

Metal with electron-like quasiparticles on a Fermi surface of size p , and emergent gauge fields

Spinon-holon bound state

FL* in a **one-band** model

S. Sachdev *Phys. Rev. B* **49**, 6770 (1994); X.-G. Wen and P.A. Lee *Phys. Rev. Lett.* **76**, 503 (1996)

R. K. Kaul, A. Kolezhuk, M. Levin, S. Sachdev, and T. Senthil, *Phys. Rev. B* **75**, 235122 (2007)

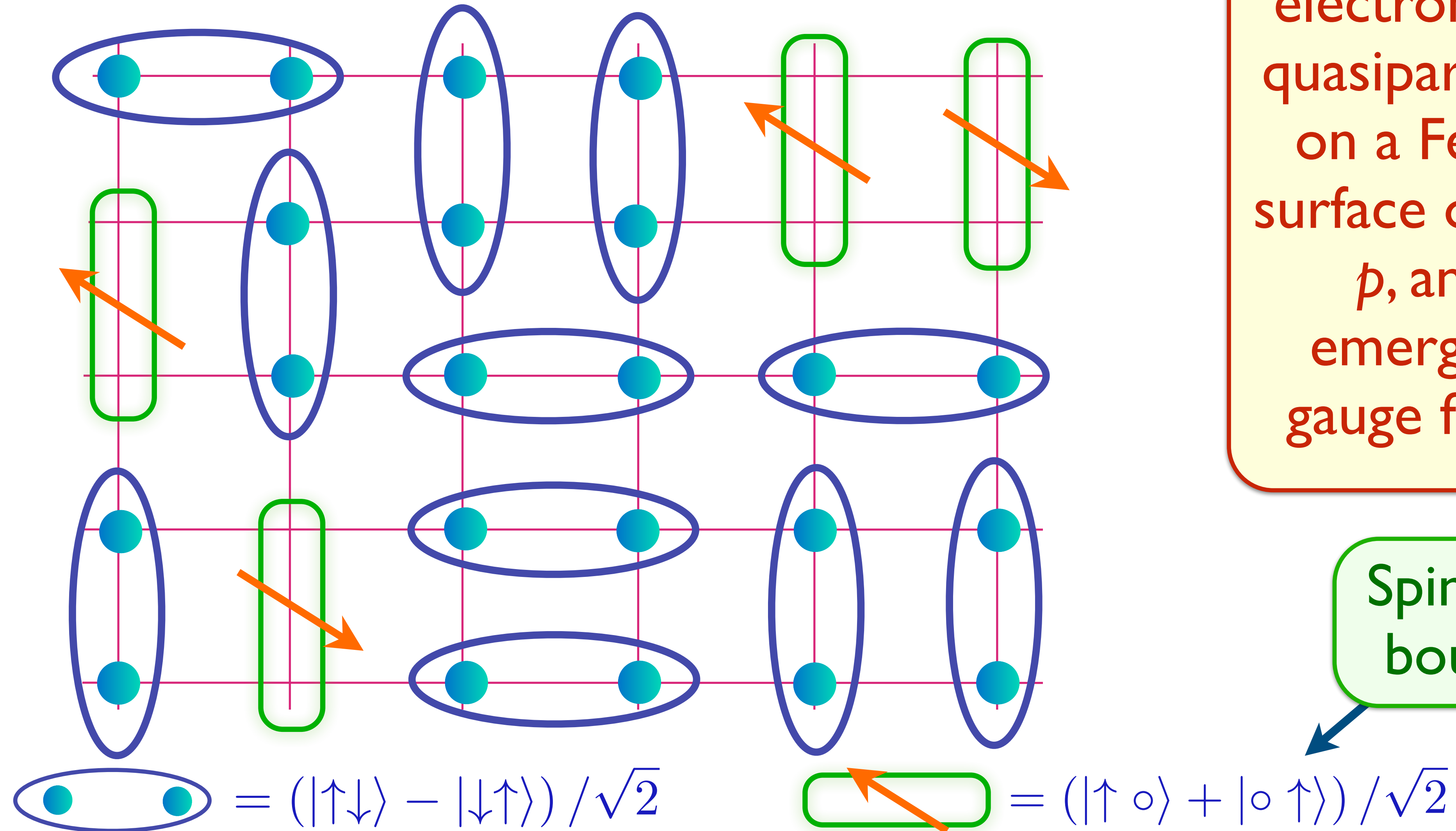

Metal with electron-like quasiparticles on a Fermi surface of size p , and emergent gauge fields

Spinon-holon bound state

FL* in a **one-band** model

S. Sachdev *Phys. Rev. B* **49**, 6770 (1994); X.-G. Wen and P.A. Lee *Phys. Rev. Lett.* **76**, 503 (1996)

R. K. Kaul, A. Kolezhuk, M. Levin, S. Sachdev, and T. Senthil, *Phys. Rev. B* **75**, 235122 (2007)

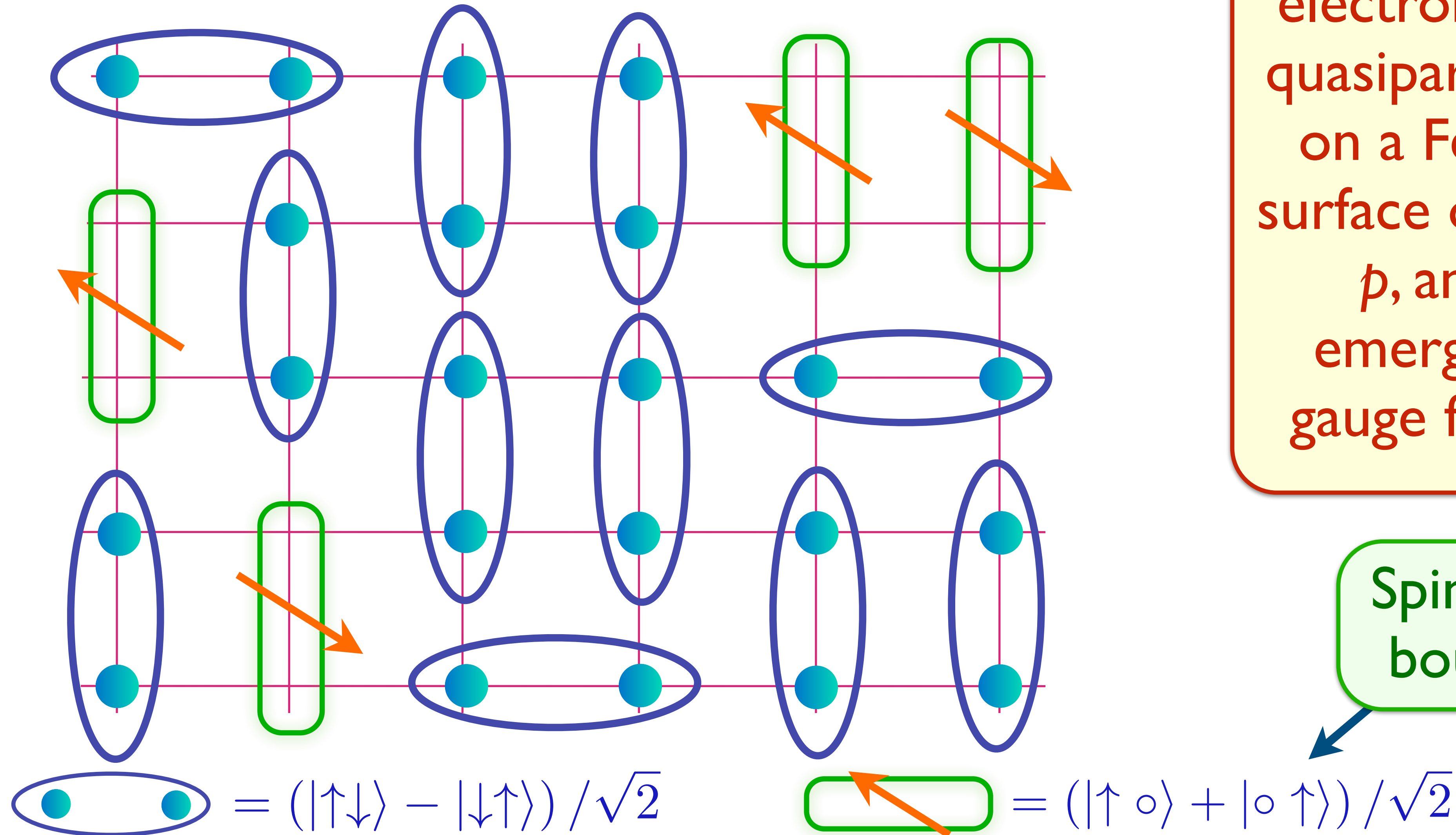

FL* in a **one-band** model

S. Sachdev *Phys. Rev. B* **49**, 6770 (1994); X.-G. Wen and P.A. Lee *Phys. Rev. Lett.* **76**, 503 (1996)

R. K. Kaul, A. Kolezhuk, M. Levin, S. Sachdev, and T. Senthil, *Phys. Rev. B* **75**, 235122 (2007)

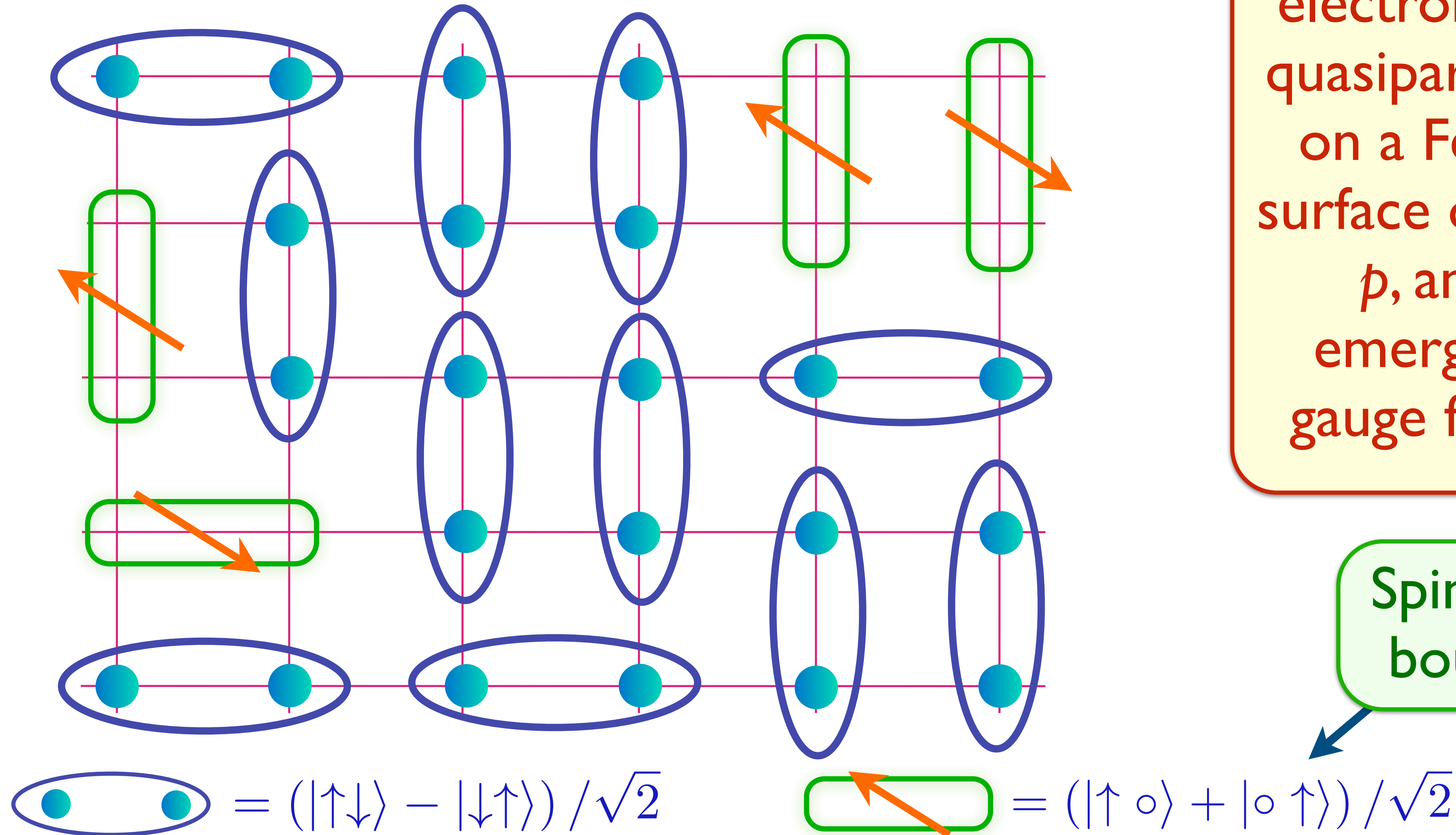

Metal with electron-like quasiparticles on a Fermi surface of size p , and emergent gauge fields

Spinon-holon bound state

FL* in a **one-band** model

S. Sachdev *Phys. Rev. B* **49**, 6770 (1994); X.-G. Wen and P.A. Lee *Phys. Rev. Lett.* **76**, 503 (1996)

R. K. Kaul, A. Kolezhuk, M. Levin, S. Sachdev, and T. Senthil, *Phys. Rev. B* **75**, 235122 (2007)

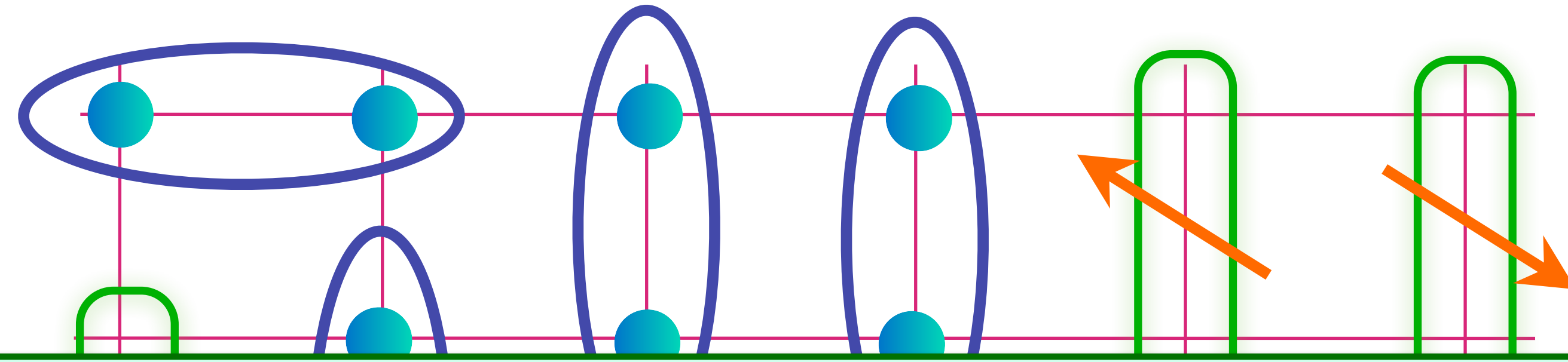

Characteristic features of the underlying spin liquid remain unchanged upon doping into the FL* state!

Metal with electron-like quasiparticles on a Fermi surface of size p , and emergent gauge fields

Spinon-holon bound state

$$\text{Spinon-holon bound state} = (|\uparrow\downarrow\rangle - |\downarrow\uparrow\rangle) / \sqrt{2}$$

$$\text{Holon} = (|\uparrow\circ\rangle + |\circ\uparrow\rangle) / \sqrt{2}$$

Which spin liquid describes
the cuprates ?

Which spin liquid describes
the cuprates ?

The CP^1/π -flux spin liquid

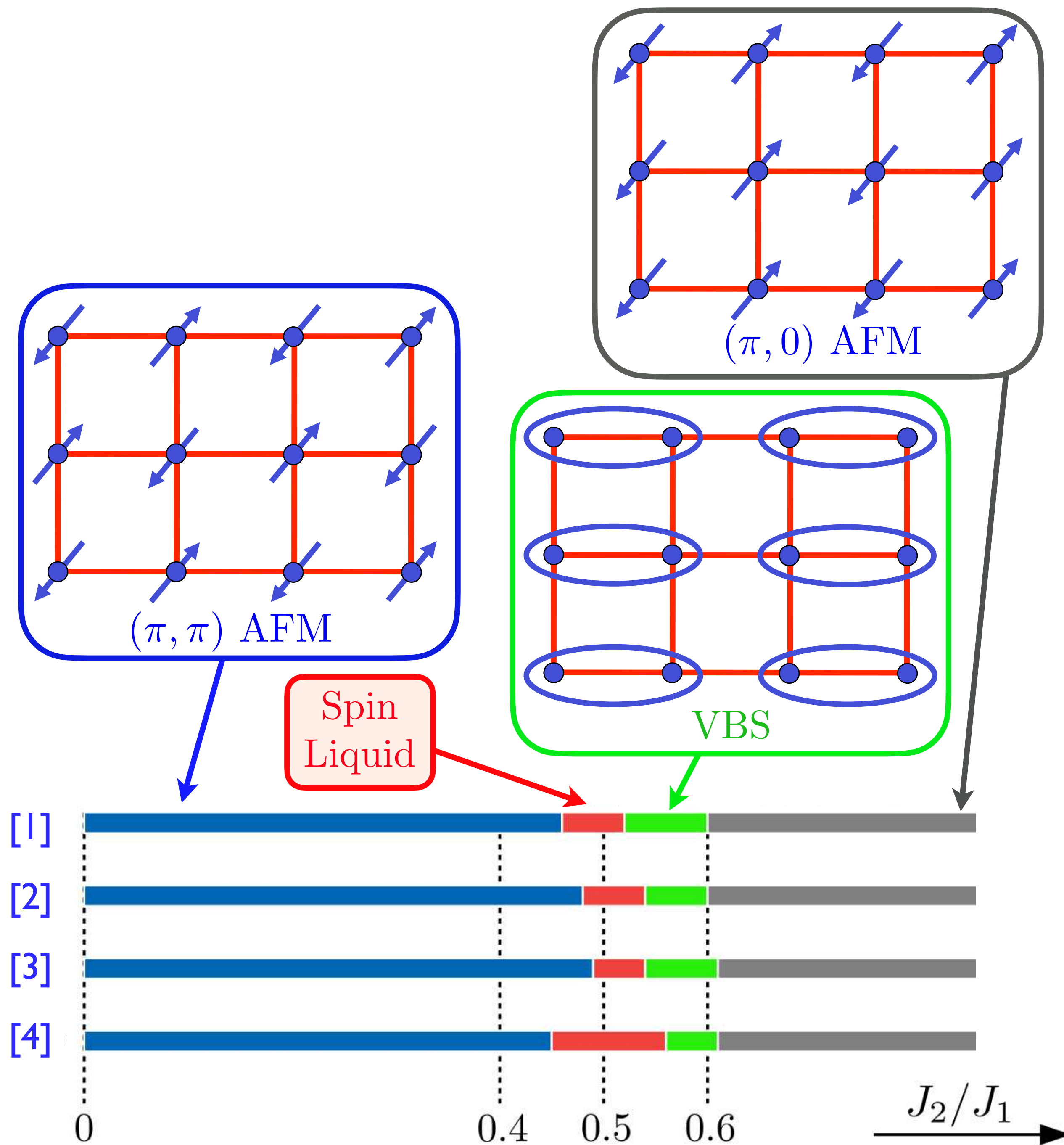

$$H = J_1 \sum_{\langle i,j \rangle} \mathbf{S}_i \cdot \mathbf{S}_j + J_2 \sum_{\langle\langle i,j \rangle\rangle} \mathbf{S}_i \cdot \mathbf{S}_j$$

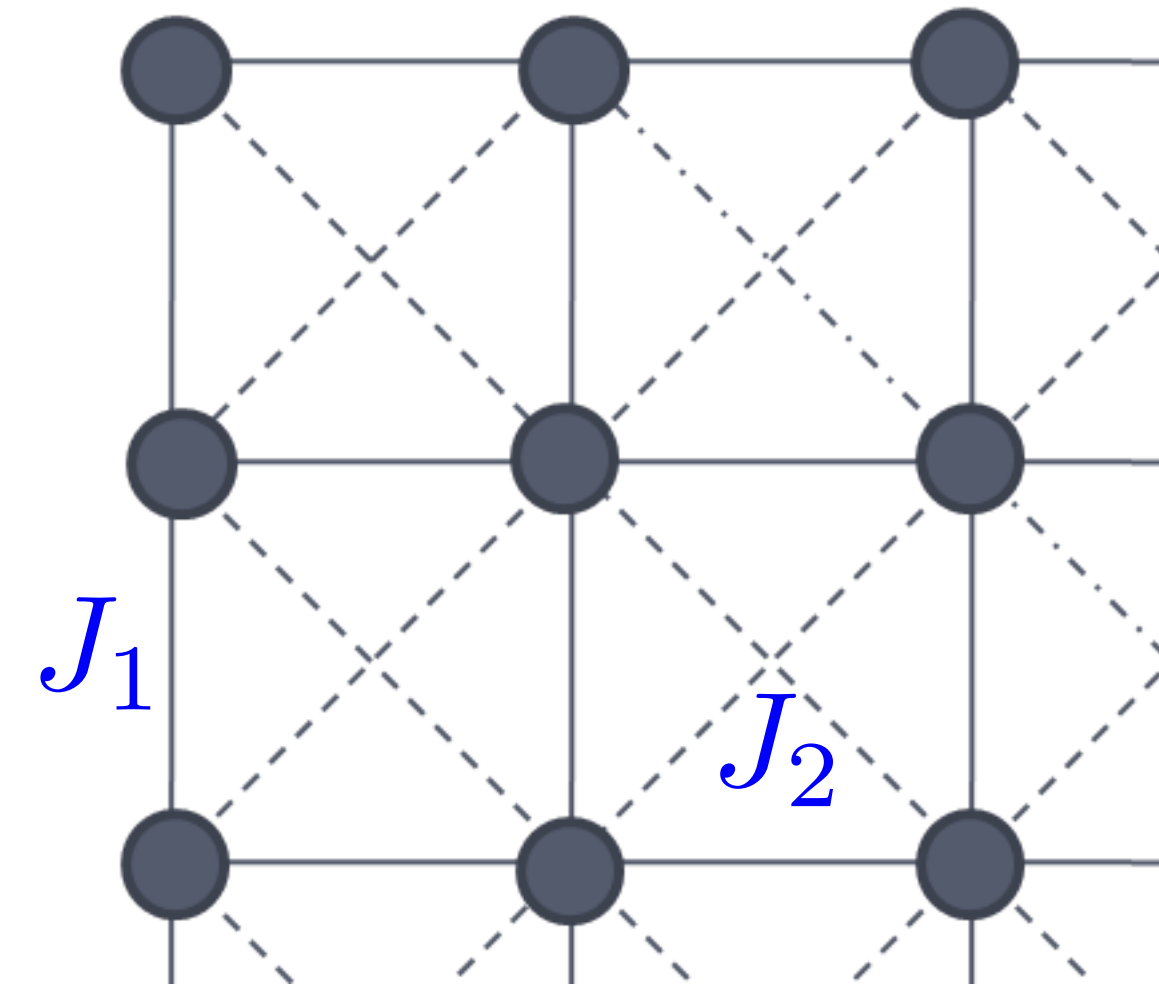

1. L. Wang and A. W. Sandvik, *Phys. Rev. Lett.* **121**, 107202 (2018)
2. F. Ferrari and F. Becca, *Phys. Rev. B* **102**, 014417 (2020)
3. Y. Nomura and M. Imada, *Phys. Rev. X* **11**, 031034 (2021)
4. W.-Y. Liu, S.-S. Gong, Y.-B. Li, D. Poilblanc, W.-Q. Chen, and Z.-C. Gu, *Science Bulletin* **67**, 1034 (2022)

Insulating $S=1/2$ antiferromagnet

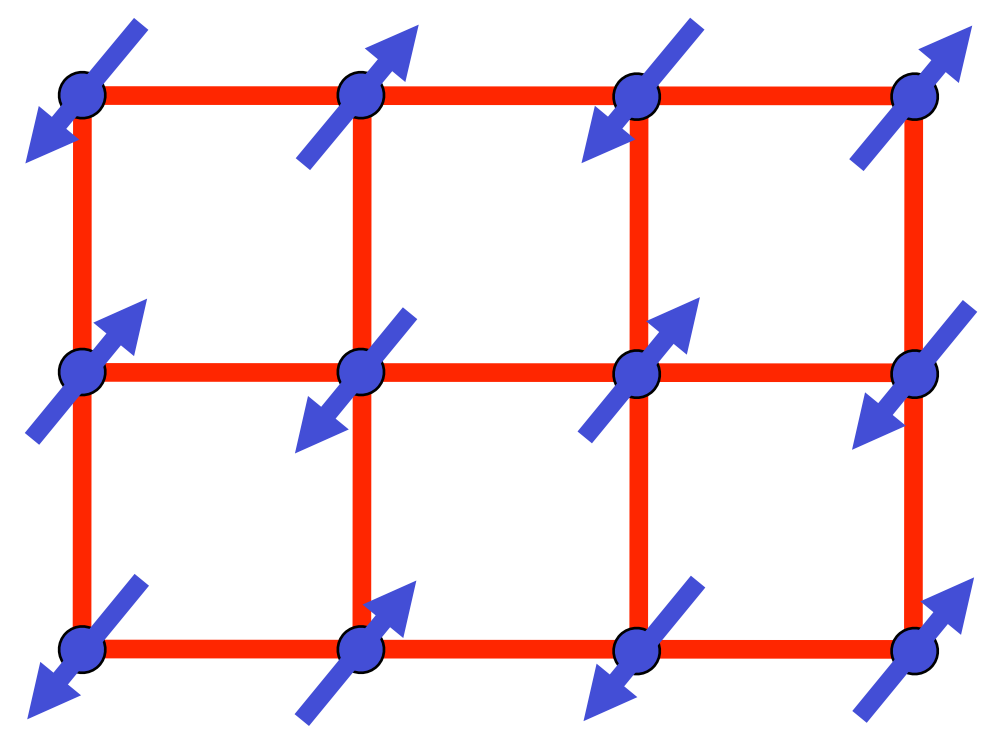

$\langle b_\alpha \rangle \neq 0$:
Néel order

$\langle b_\alpha \rangle = 0$:
Spin liquid

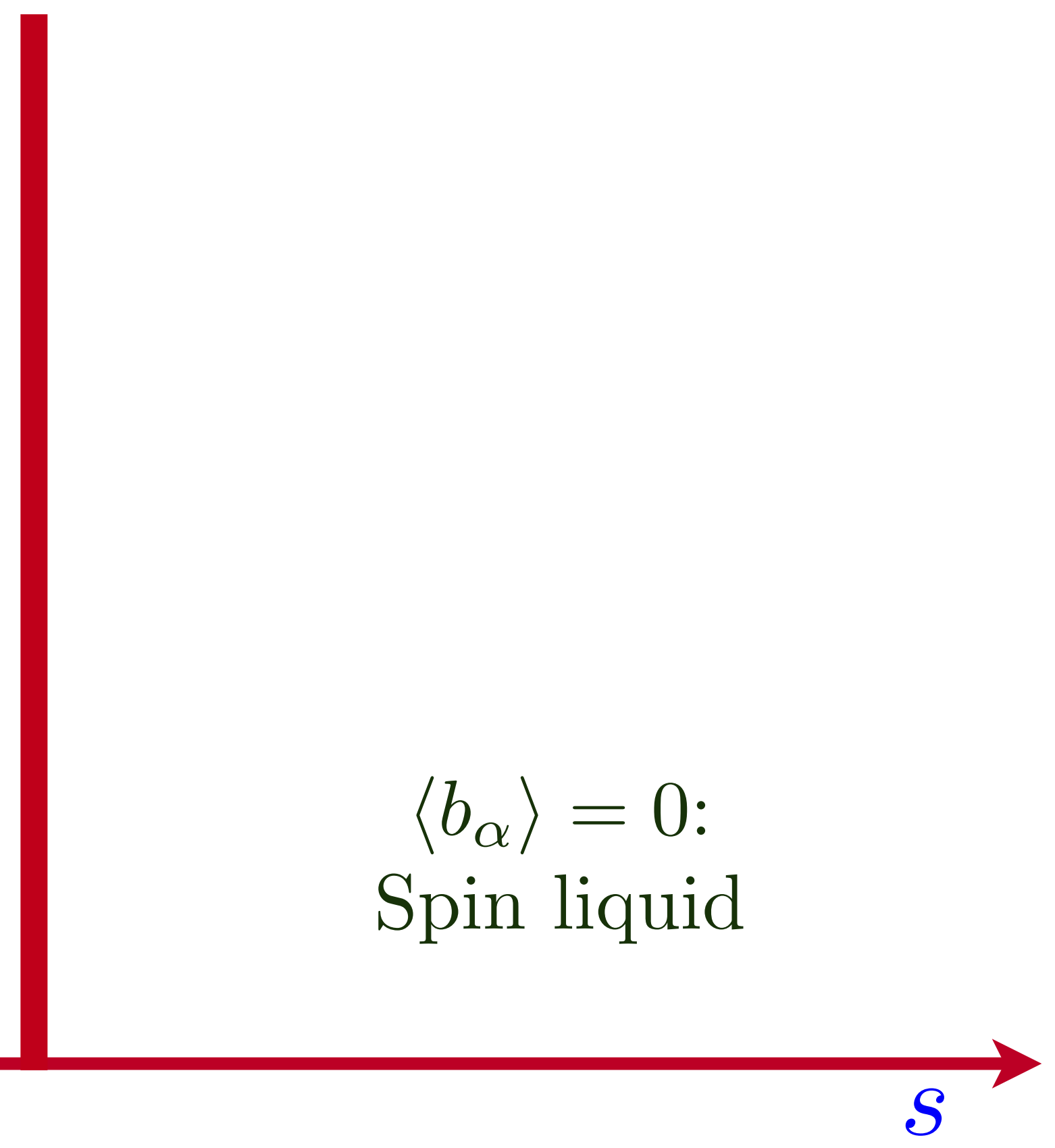

$$H = \sum_{i < j} J_{ij} \mathbf{S}_i \cdot \mathbf{S}_j$$

Schwinger bosons

$$\mathbf{S}_i = \frac{1}{2} b_{i\alpha}^\dagger \boldsymbol{\sigma}_{\alpha\beta} b_{i\beta}, \quad \sum_{\alpha=\uparrow,\downarrow} b_{i\alpha}^\dagger b_{i\alpha} = 1$$

Mean-field spin liquid
with gapped bosonic spinons.

Insulating $S=1/2$ antiferromagnet

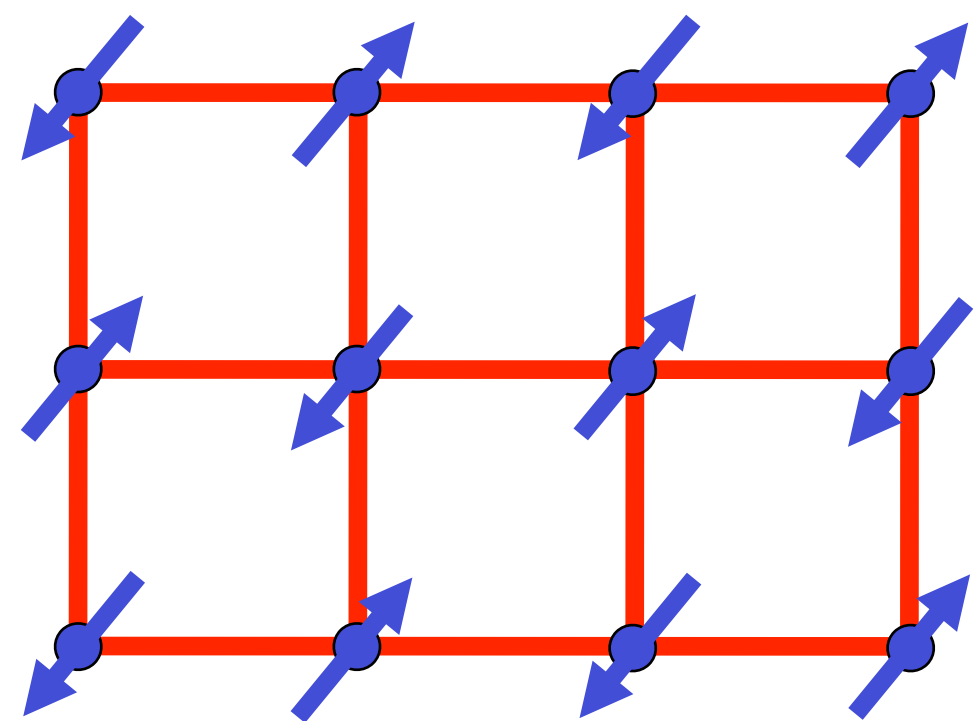

Spin liquid

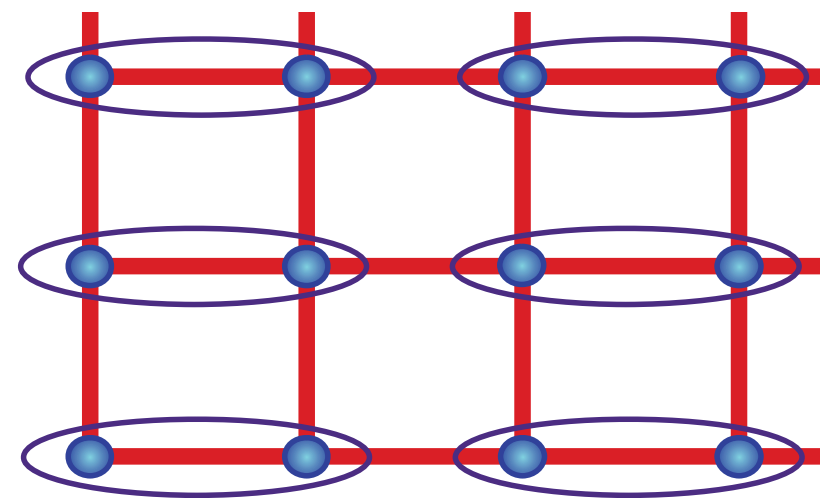

or

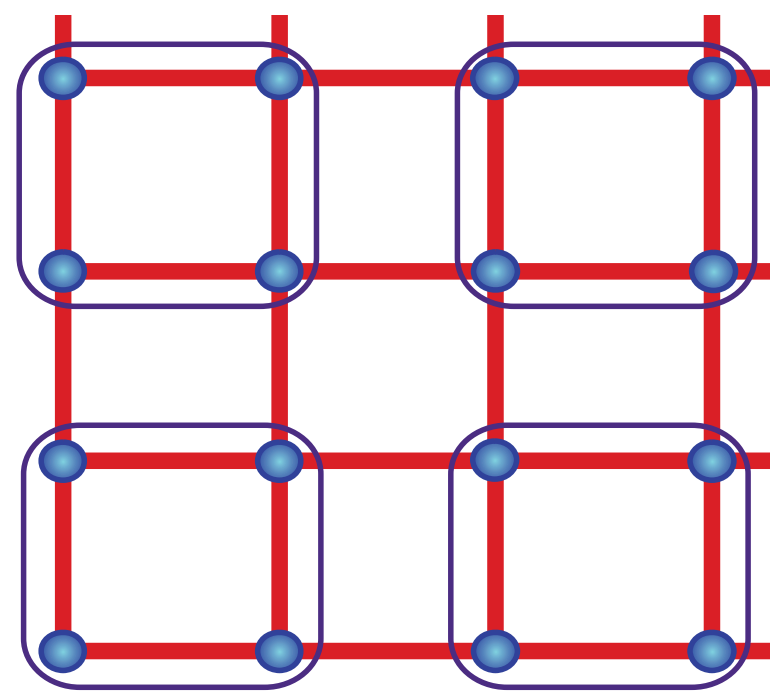

Higgs phase, $\langle z_\alpha \rangle \neq 0$:
Néel order

Confining phase, $\langle z_\alpha \rangle = 0$:
VBS order

s

$$\mathcal{L} = |(\partial_\mu - ia_\mu)z_\alpha|^2 + s|z_\alpha|^2 + u|z_\alpha|^4 + \mathcal{L}_{\text{monopole}}$$

$$H = \sum_{i < j} J_{ij} \mathbf{S}_i \cdot \mathbf{S}_j$$

Schwinger bosons

$$\mathbf{S}_i = \frac{1}{2} b_{i\alpha}^\dagger \boldsymbol{\sigma}_{\alpha\beta} b_{i\beta}, \quad \sum_{\alpha=\uparrow,\downarrow} b_{i\alpha}^\dagger b_{i\alpha} = 1$$

Mean-field spin liquid
with gapped bosonic spinons.

Low energy $\mathbb{C}\mathbb{P}^1$ U(1) gauge theory

$$z_\alpha \sim b_{A\alpha} + \varepsilon_{\alpha\beta} b_{B\beta}$$

Insulating $S=1/2$ antiferromagnet

$$H = \sum_{i < j} J_{ij} \mathbf{S}_i \cdot \mathbf{S}_j$$

Schwinger fermions

$$\mathbf{S}_i = \frac{1}{2} f_{i\alpha}^\dagger \boldsymbol{\sigma}_{\alpha\beta} f_{i\beta}, \quad \sum_{\alpha=\uparrow,\downarrow} f_{i\alpha}^\dagger f_{i\alpha} = 1$$

π -flux mean-field theory
with gapless spinons at 2 Dirac points.

I. Affleck and J.B. Marston, PRB **37**, 3774 (1988)

Spin liquid

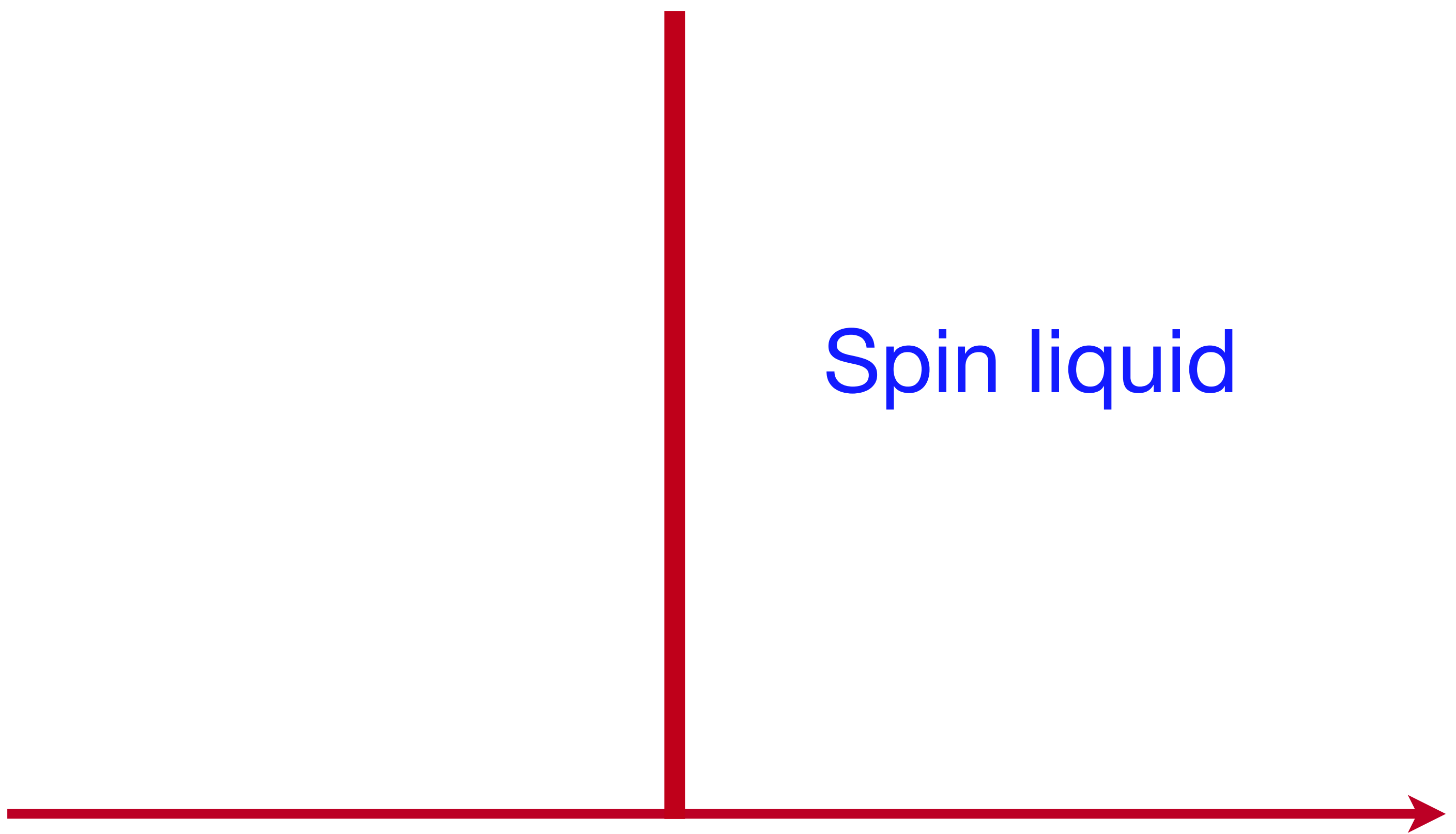

$$H_f = iJ \sum_{\langle ij \rangle} e_{ij} \left(f_{i\alpha}^\dagger f_{j\alpha} - f_{j\alpha}^\dagger f_{i\alpha} \right), \quad \epsilon_{\mathbf{k}} = 2J \sqrt{\sin^2(k_x) + \sin^2(k_y)}$$

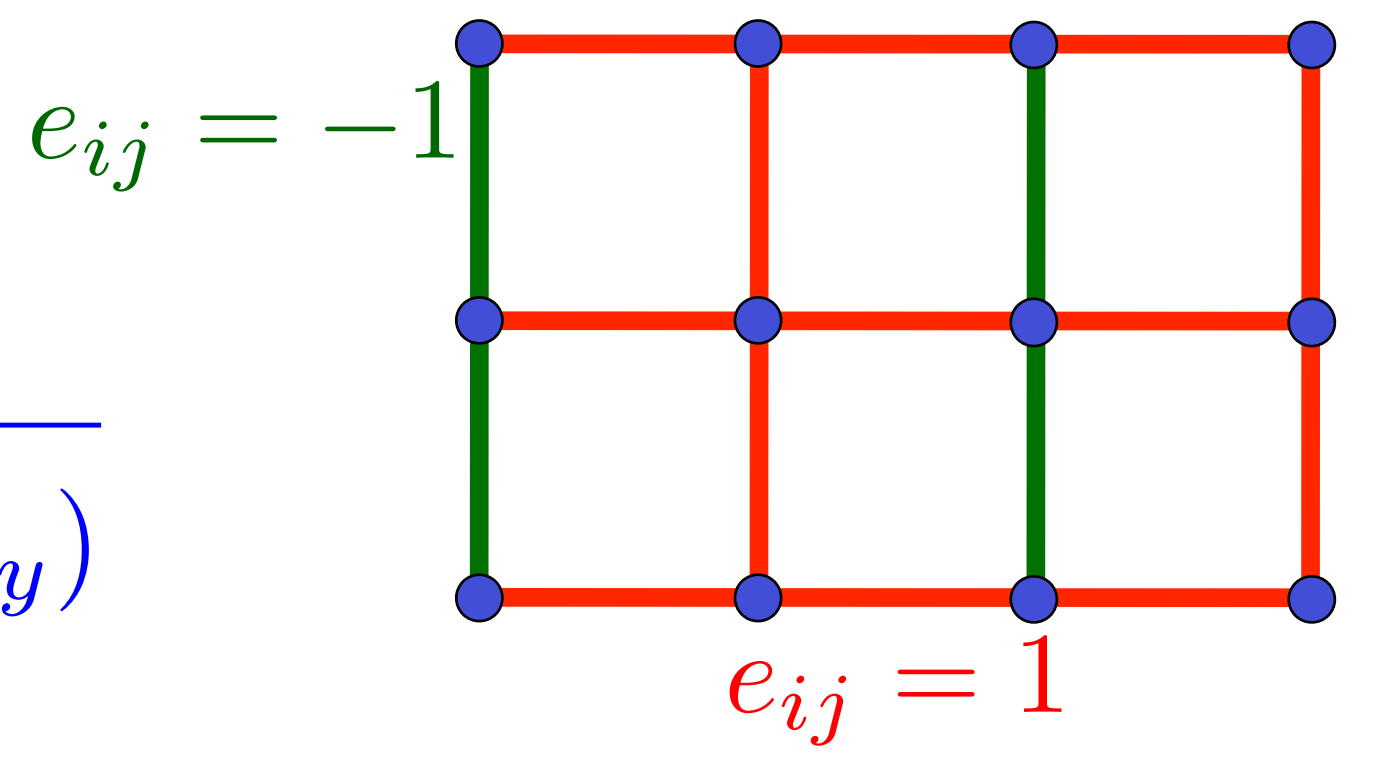

\mathbb{CP}^1 U(1) gauge theory

$S=1/2$
square
lattice anti-
ferromagnet

SU(2) gauge theory of $N_f = 2$
fundamental, massless, Dirac fermions.

Obtained from a saddle-point of
fermionic spinons moving in π -flux.

I. Affleck and J.B. Marston, *Phys. Rev. B* **37**, 3774 (1988)

SO(5) non-linear σ -model
of Néel/VBS orders
with $k = 1$ WZW term

\mathbb{CP}^1 U(1) gauge theory

$S=1/2$
square
lattice anti-
ferromagnet

SU(2) gauge theory of $N_f = 2$
fundamental, massless, Dirac fermions.

Obtained from a saddle-point of
fermionic spinons moving in π -flux.

I. Affleck and J.B. Marston, *Phys. Rev. B* **37**, 3774 (1988)

SO(5) non-linear σ -model
of Néel/VBS orders
with $k = 1$ WZW term

Many numerical works show that deconfined critical theory applies over a substantial length scale, but ultimately confines at the longest distances.

Anders W. Sandvik *Phys. Rev. Lett.* **98**, 227202 (2007)

Adam Nahum, P. Serna, J. T. Chalker, M. Ortuño, and A. M. Somoza, *Phys. Rev. Lett.* **115**, 267203 (2015)

Z. Zhou, L. Hu, W. Zhu, and Yin-Chen He, arXiv:2306.16435

High Temperature Superconductivity in a Lightly Doped Quantum Spin Liquid

Hong-Chen Jiang^{1,*} and Steven A. Kivelson²

Phys. Rev. Lett. **127**, 097002 (2021)

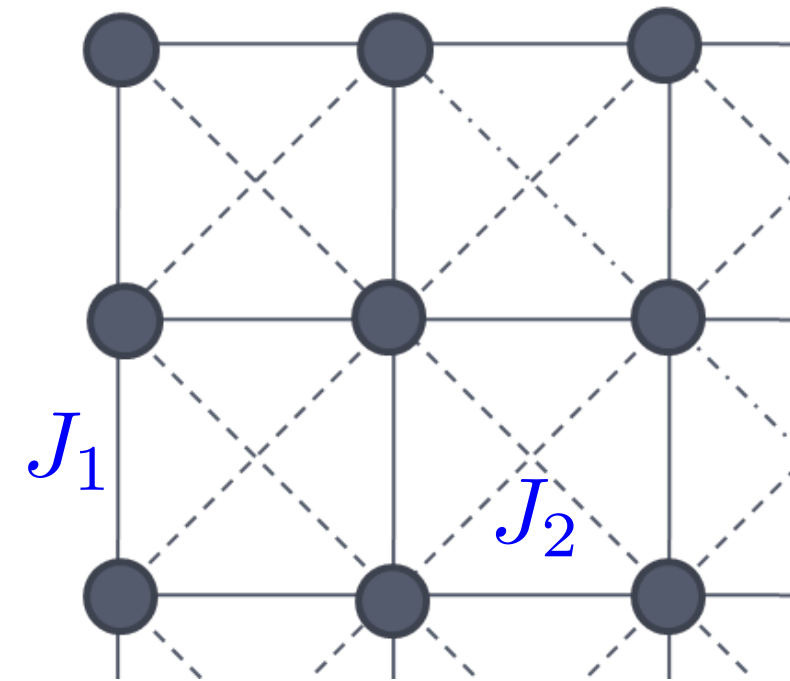
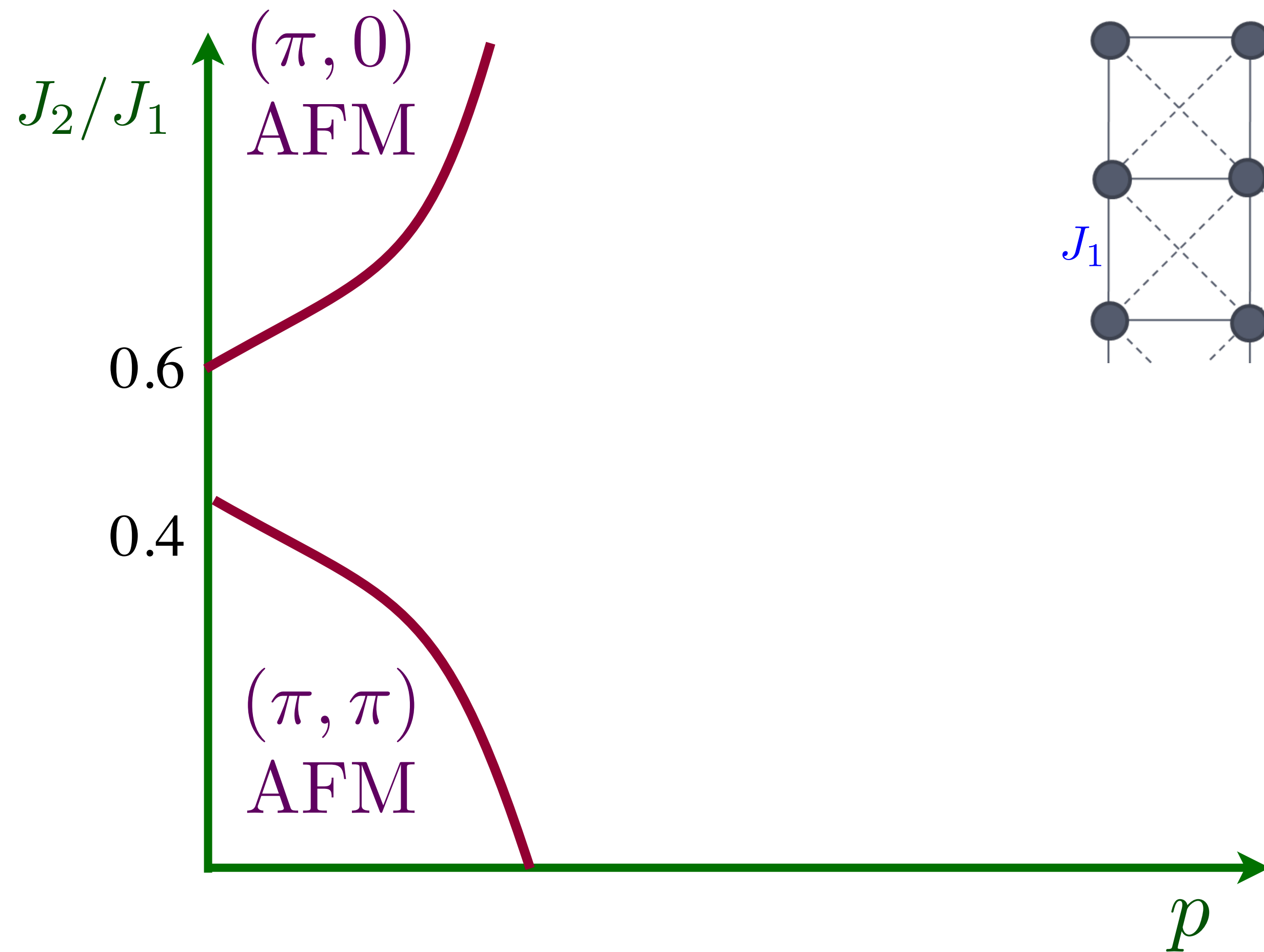

Superconducting valence bond fluid in
lightly doped 8-leg t - J cylinders
Hong-Chen Jiang, Steven A. Kivelson, and
Dung-Hai Lee, arXiv:2302.11633

Upon increasing the cylinder width from 4 to 8, we observed a significant strengthening of the quasi-long-range superconducting correlations, and a dramatic suppression of any “competing” charge-density-wave order. Extrapolating from the observed behavior of the width 8 cylinders, we speculate that the system has a nodeless d-wave superconducting ground-state in the 2D limit.

High Temperature Superconductivity in a Lightly Doped Quantum Spin Liquid

Hong-Chen Jiang^{1,*} and Steven A. Kivelson²

Phys. Rev. Lett. **127**, 097002 (2021)

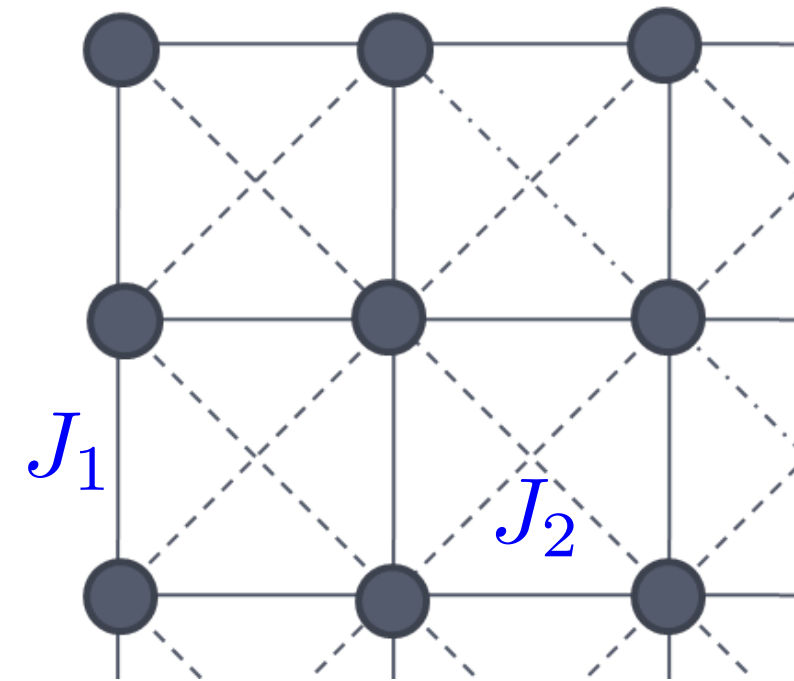
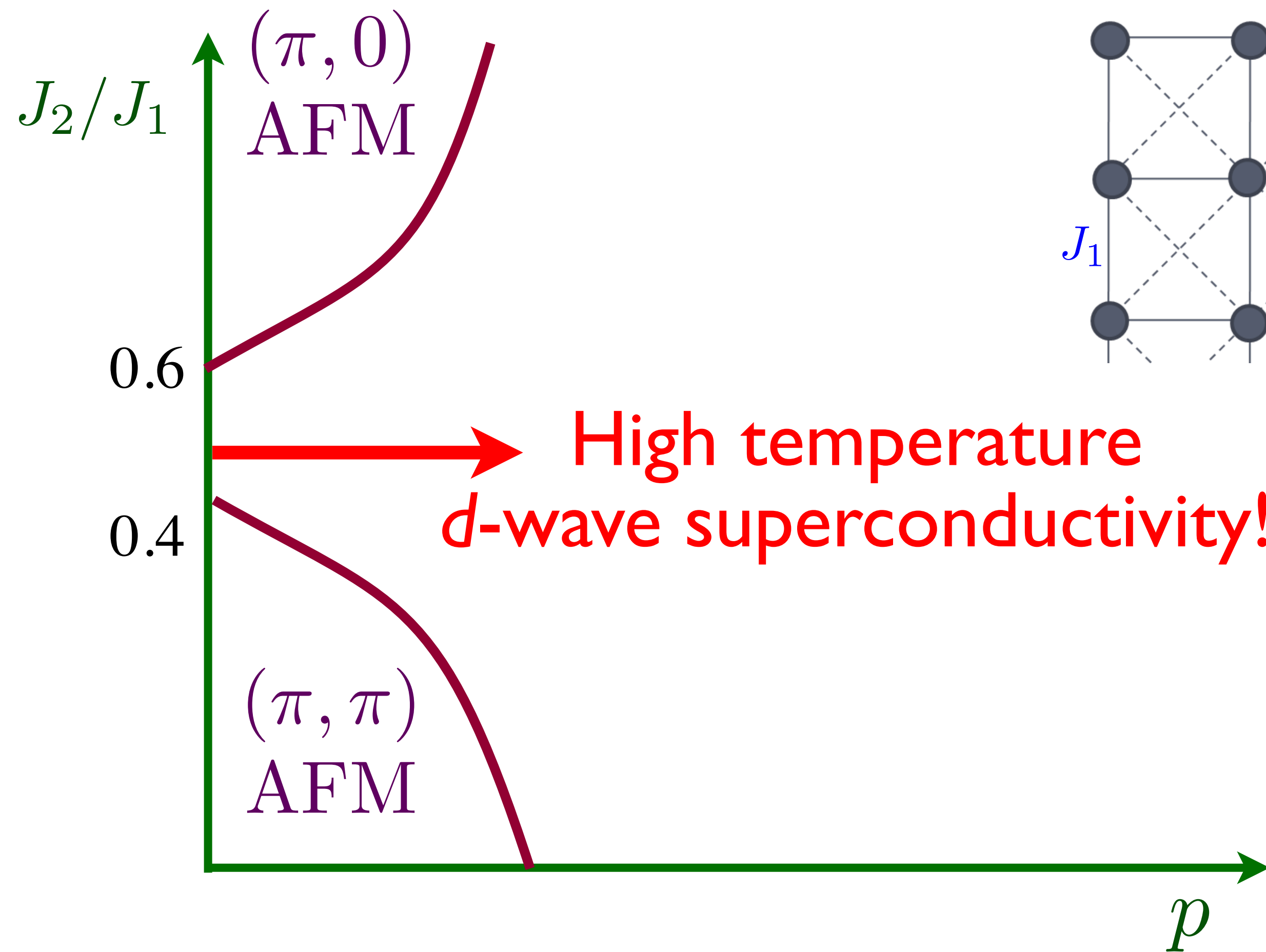

Superconducting valence bond fluid in lightly doped 8-leg t - J cylinders
Hong-Chen Jiang, Steven A. Kivelson, and Dung-Hai Lee, arXiv:2302.11633

Upon increasing the cylinder width from 4 to 8, we observed a significant strengthening of the quasi-long-range superconducting correlations, and a dramatic suppression of any “competing” charge-density-wave order. Extrapolating from the observed behavior of the width 8 cylinders, we speculate that the system has a nodeless d-wave superconducting ground-state in the 2D limit.

From FL^* to
d-wave superconductivity

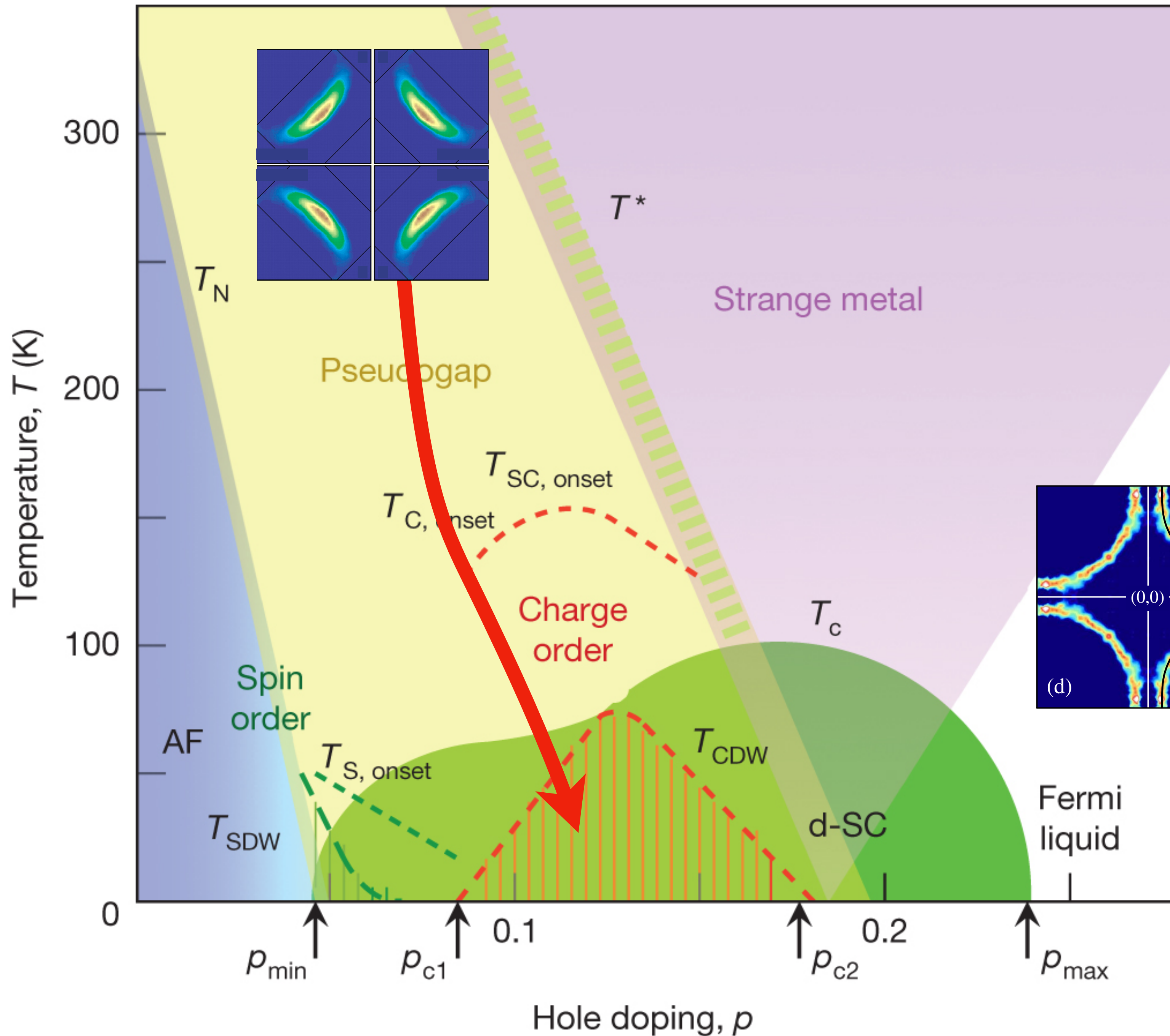

Build a theory for the phase diagram from a theory of the pseudogap metal as a ‘metastable’ $T = 0$ quantum phase.

Lowest T phases obtained from pseudogap metal should connect smoothly to conventionally order phases obtained from the Fermi liquid.

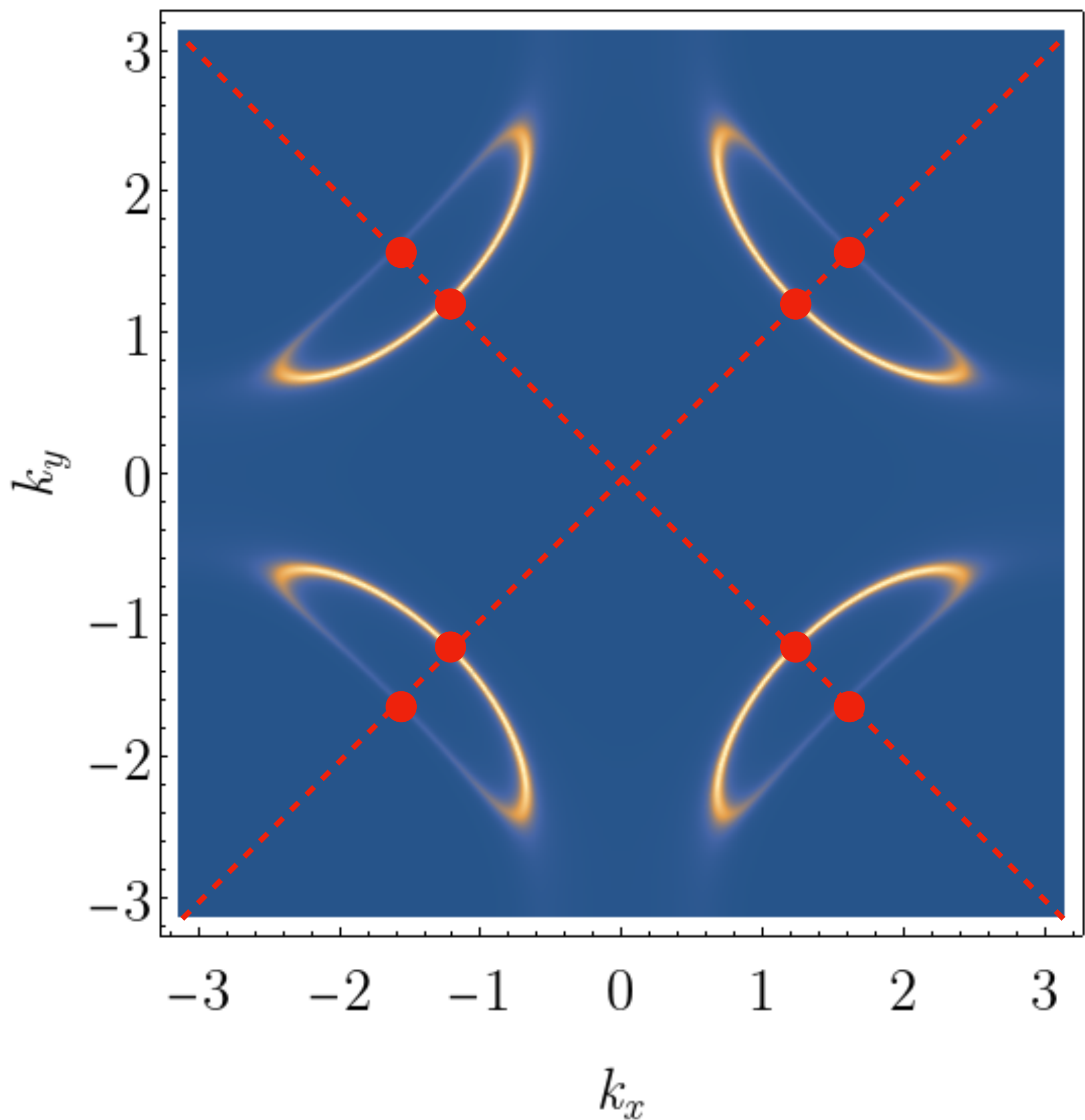

$$|A_c(\omega=0, k_x, k_y)|/A_0$$

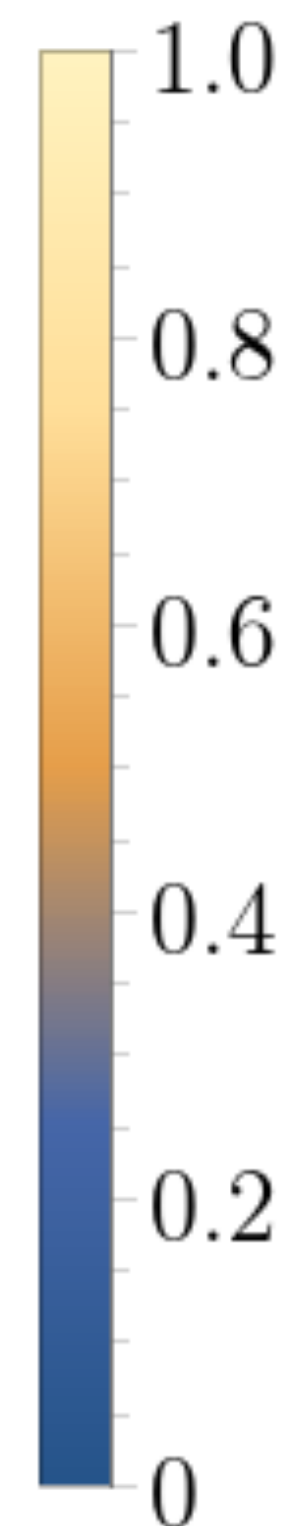

$$E_{\mathbf{k}} = (\varepsilon_{\mathbf{k}}^2 + \Delta_{\mathbf{k}}^2)^{1/2}$$

$$\Delta_{\mathbf{k}} = \Delta_0 (\cos k_x - \cos k_y)$$

Adding *d*-wave pairing
to the hole pockets
leads to 8 nodal points???

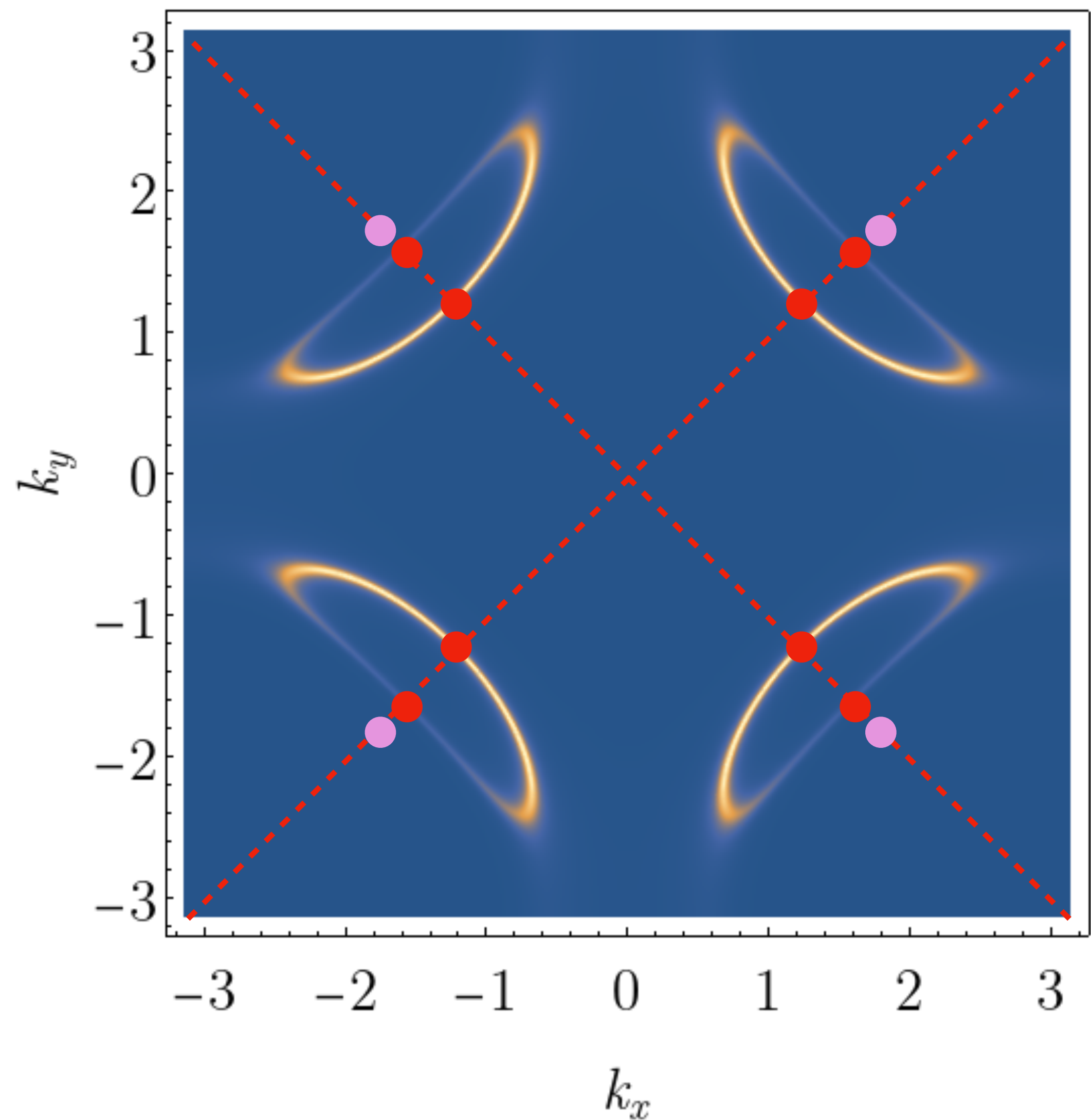

$$|A_c(\omega=0, k_x, k_y)|/A_0$$

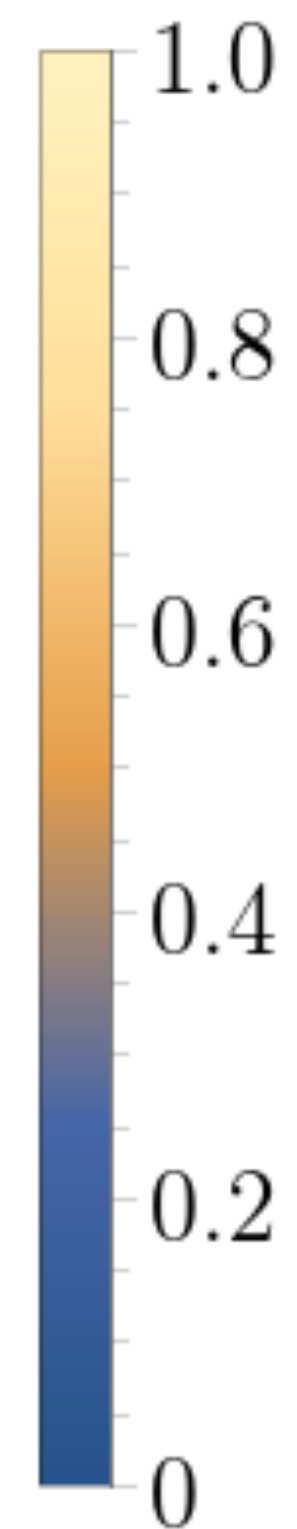

8 nodal points from
the Fermi pockets
and
4 nodal points from
the π -flux spin liquid

Shubhayu Chatterjee and S. Sachdev,
PRB **94**, 205117 (2016)
Maine Christos and S.Sachdev,
arXiv:2308.03835

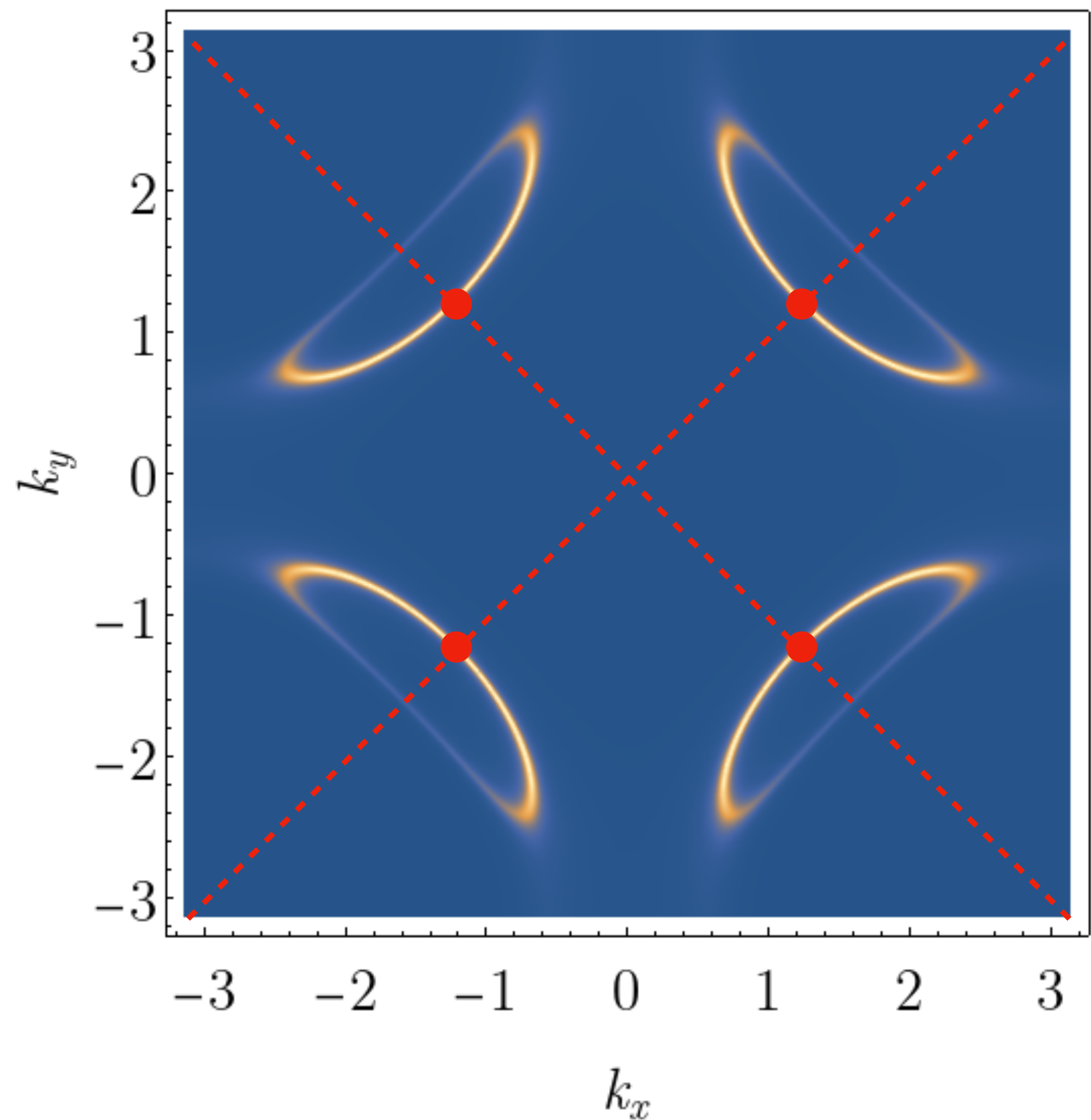

$$|A_c(\omega=0, k_x, k_y)|/A_0$$

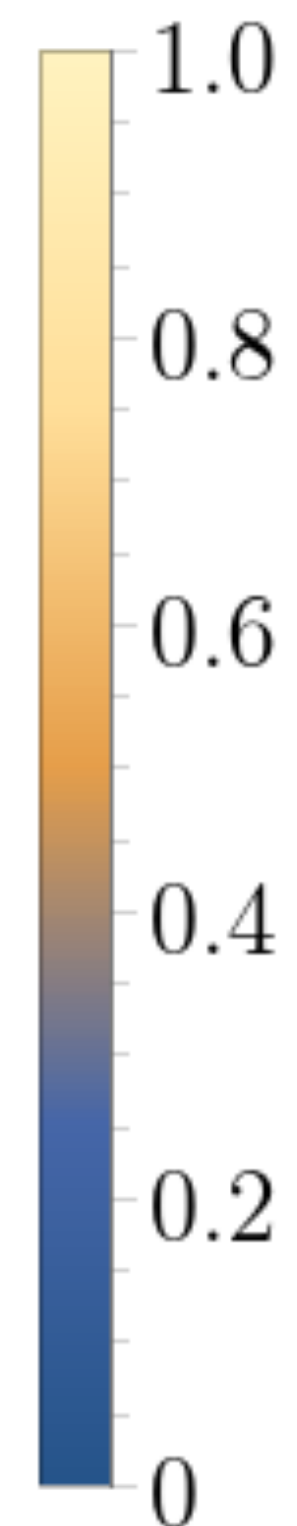

8 nodal points annihilate
each other, leaving
4 nodal points
with anisotropic velocities,
just as in a BCS *d*-wave state.

Shubhayu Chatterjee and S. Sachdev,
PRB **94**, 205117 (2016)

Maine Christos and S.Sachdev,
arXiv:2308.03835

Electron spectral density in hole-doped cuprates

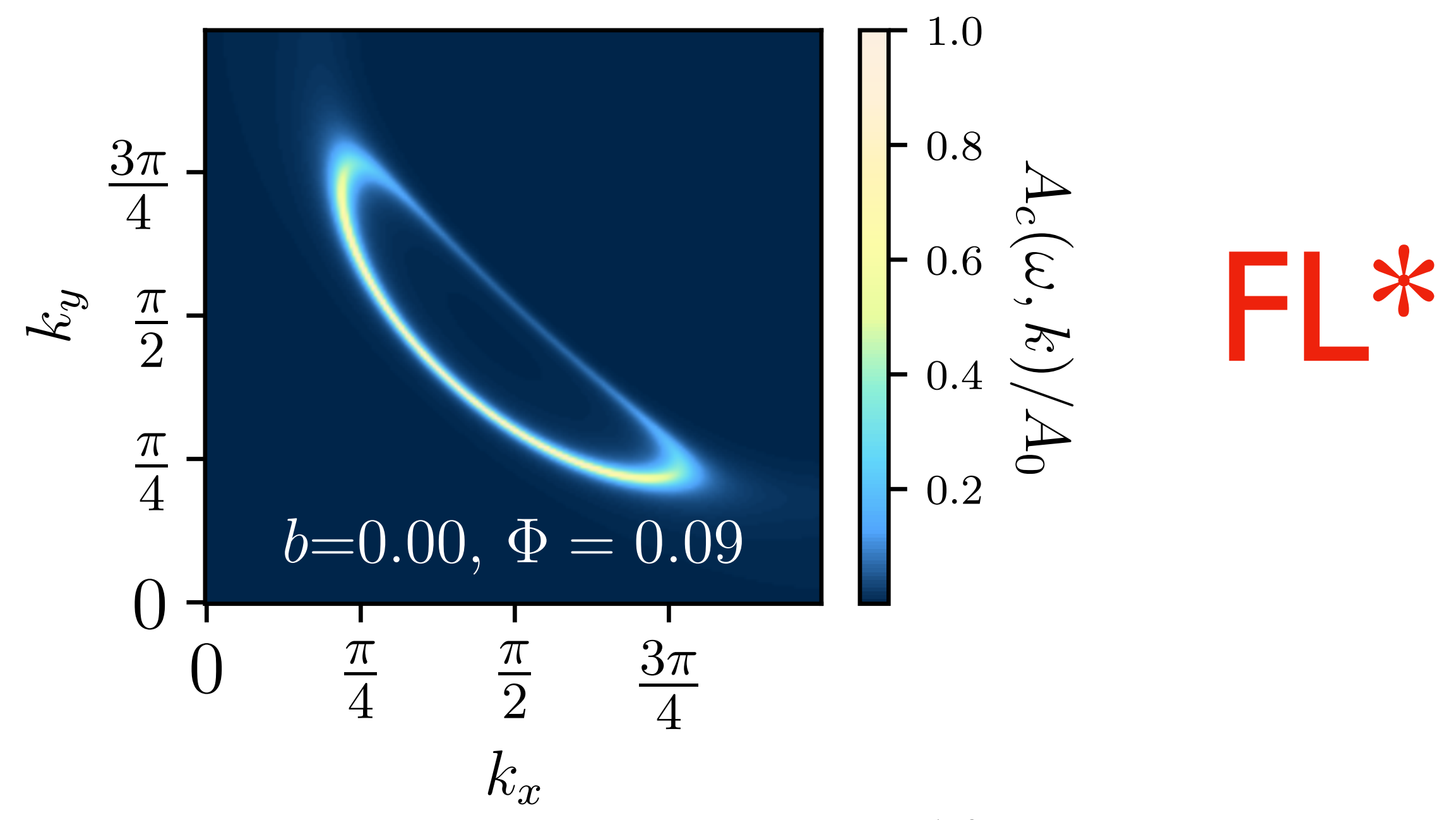

d-wave superconductor obtained by condensing charge-*e*, SU(2) fundamental boson.

Spinons of the π -flux state annihilate the extra nodes in the *d*-wave superconductor.

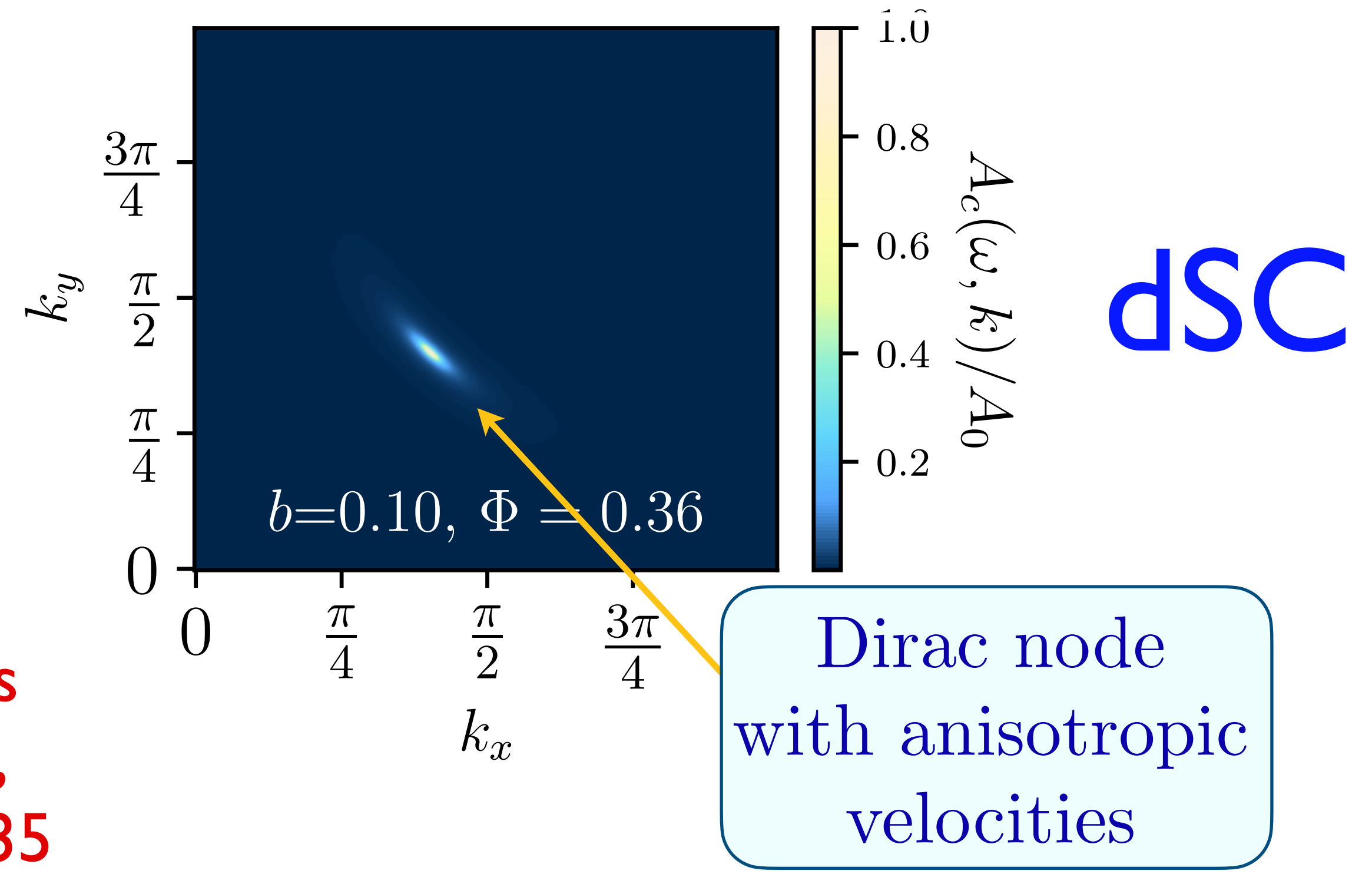

Maine Christos and S.Sachdev, arXiv:2308.03835

Electron spectral density in hole-doped cuprates

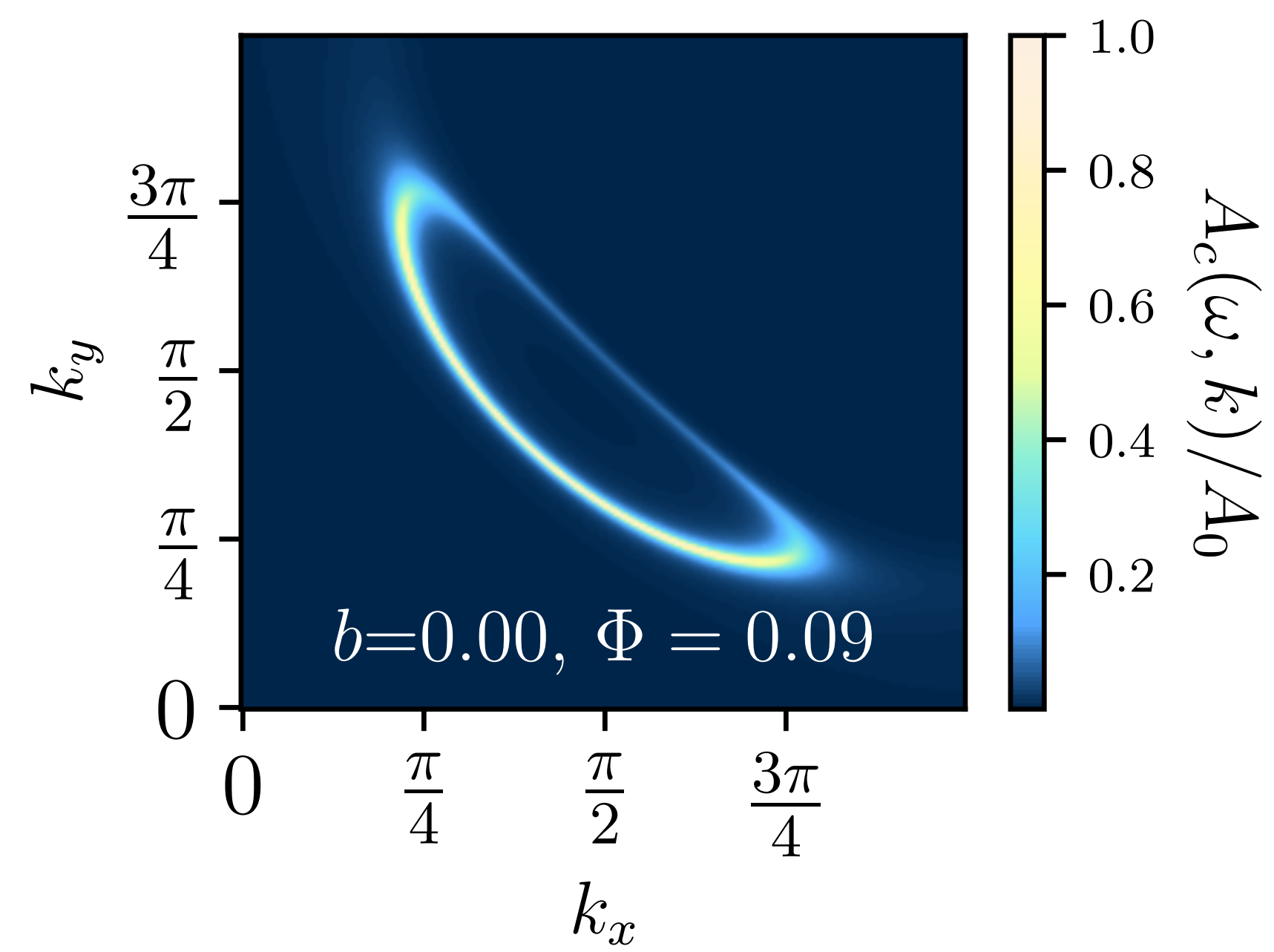

FL*

d-wave superconductor obtained by condensing charge-*e*, SU(2) fundamental boson.

Spinons of the π -flux state annihilate the extra nodes in the *d*-wave superconductor.



Maine Christos and S.Sachdev, arXiv:2308.03835

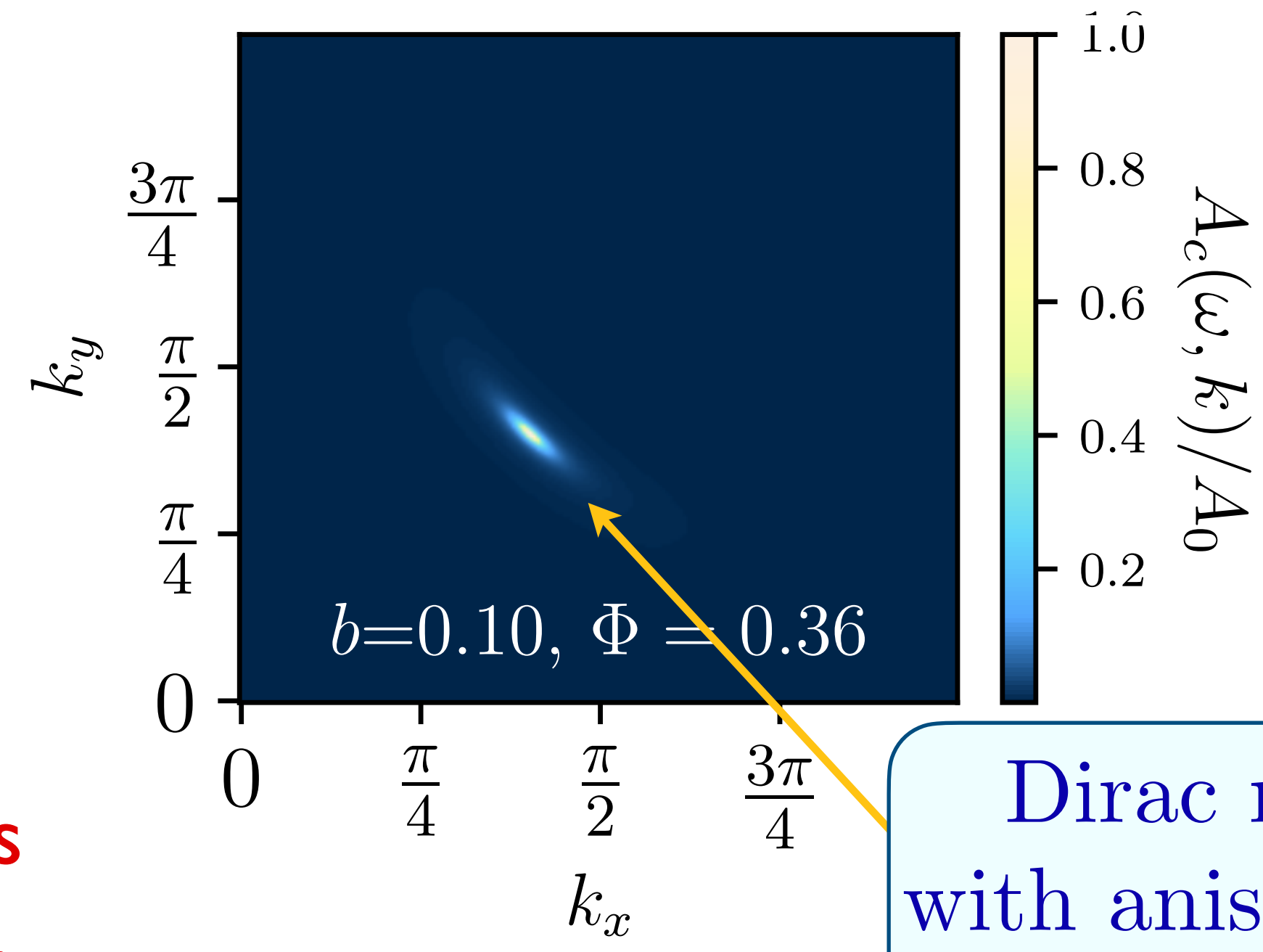

dSC

Dirac node with anisotropic velocities

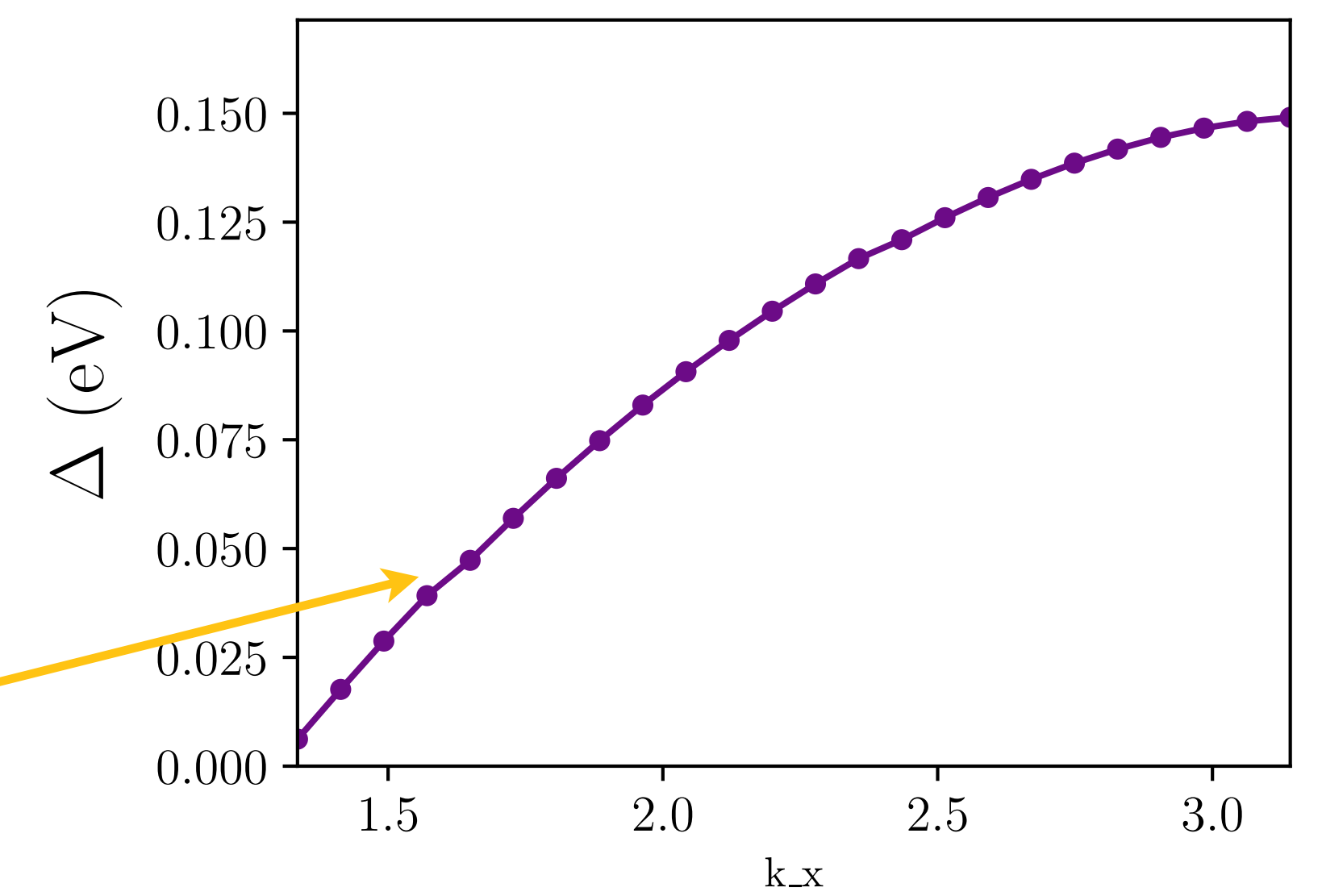

Electron spectral density in electron-doped cuprates

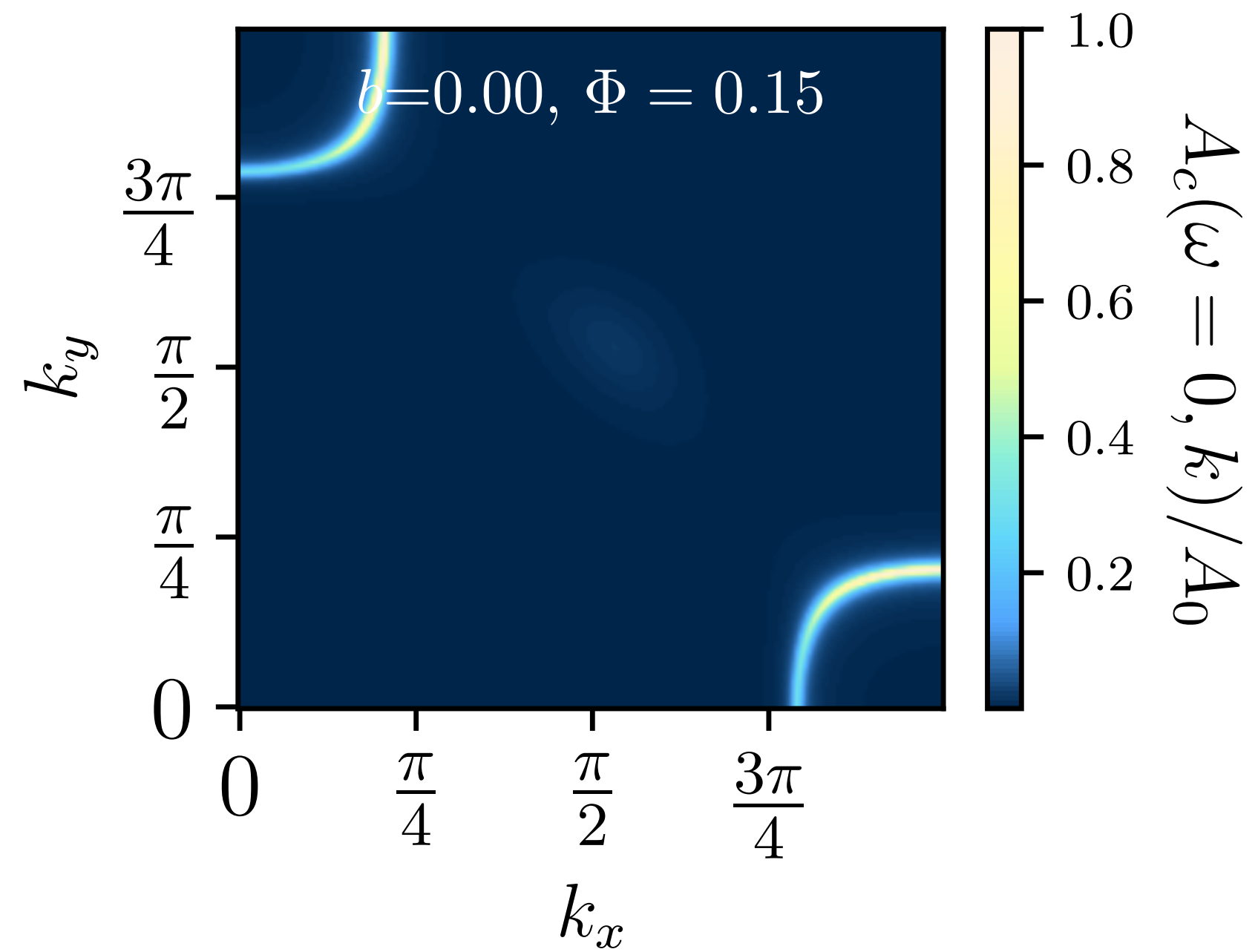

FL*

d-wave superconductor obtained by condensing charge-*e*, SU(2) fundamental boson.

Nodes of the *d*-wave superconductor are remnants of the spinons of the π -flux state.

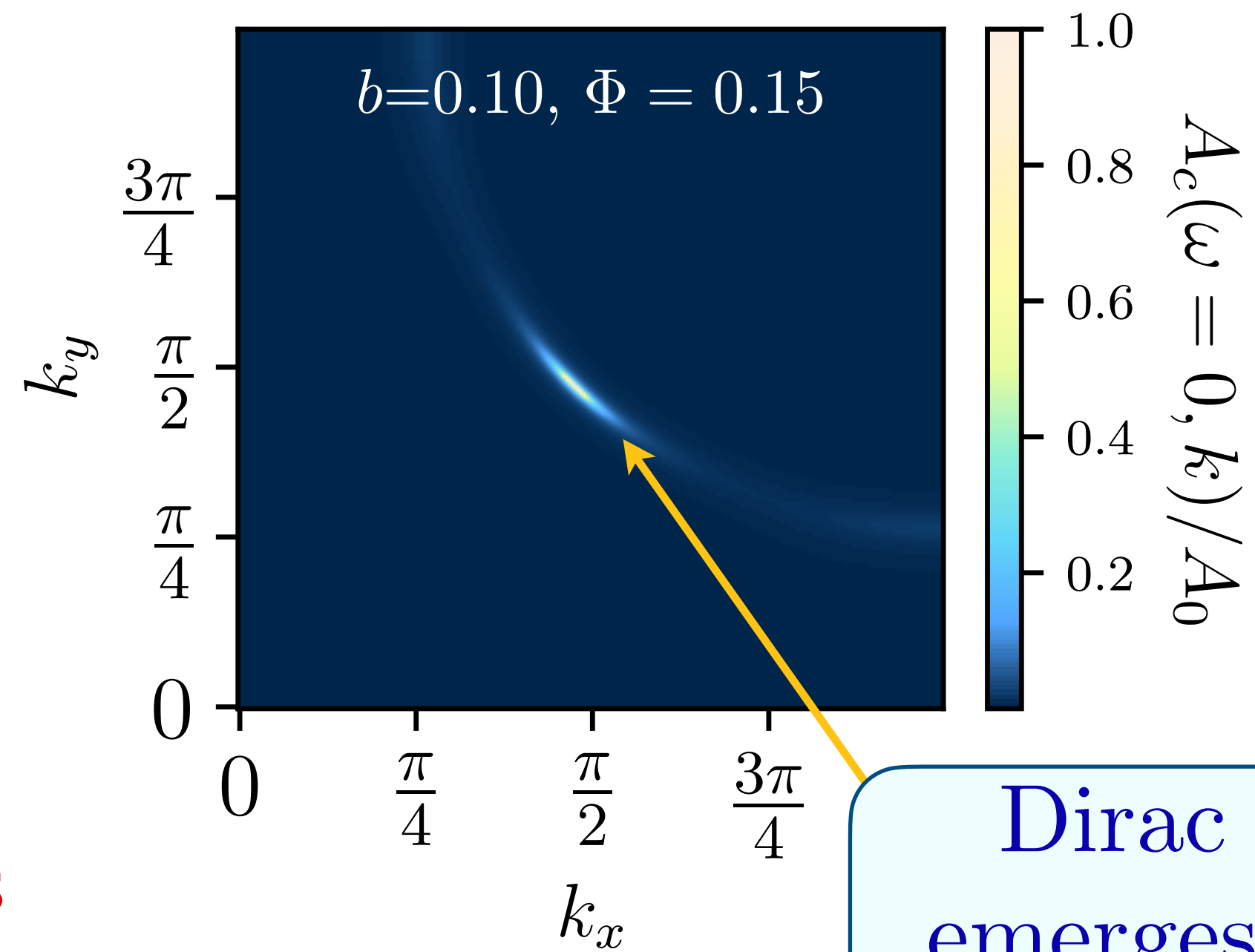

dSC

Dirac node emerges inside normal state gap



Maine Christos and S.Sachdev, arXiv:2308.03835

Electron spectral density in electron-doped cuprates

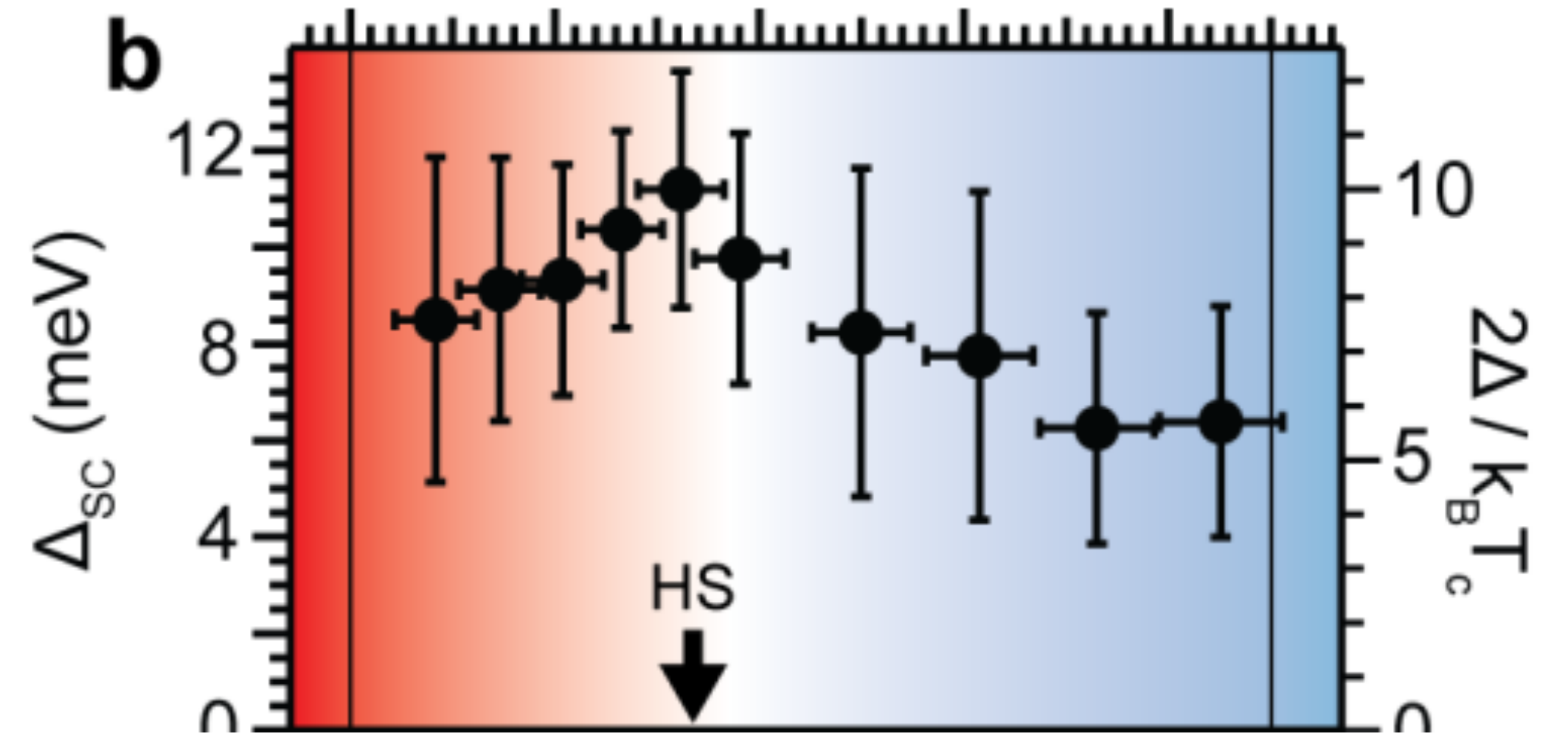
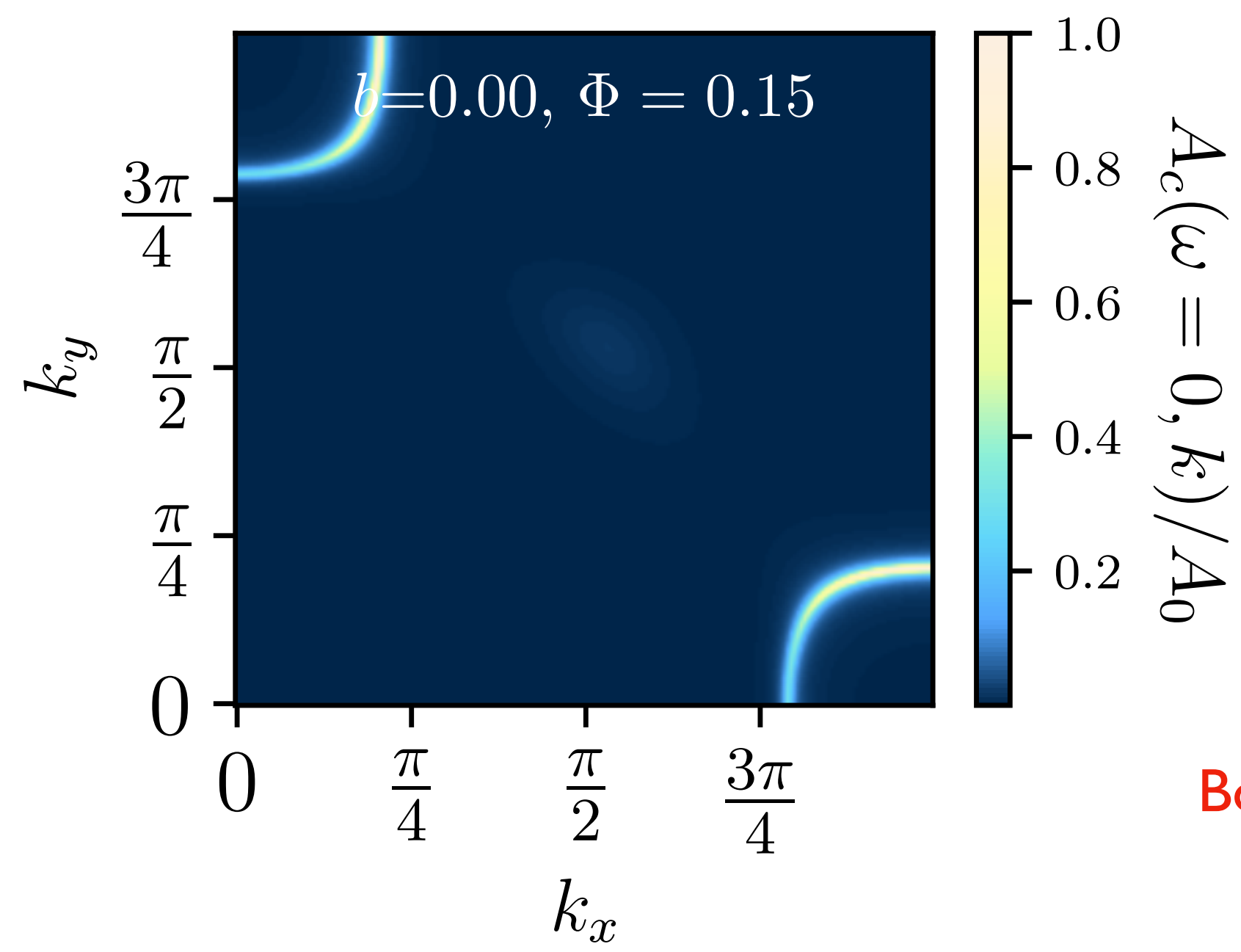

Bogoliubov Quasiparticle on the Gossamer Fermi Surface in Electron-Doped Cuprates, Ke-Jun Xu.....Z.-X. Shen, arXiv:2308.05313; Nature Physics

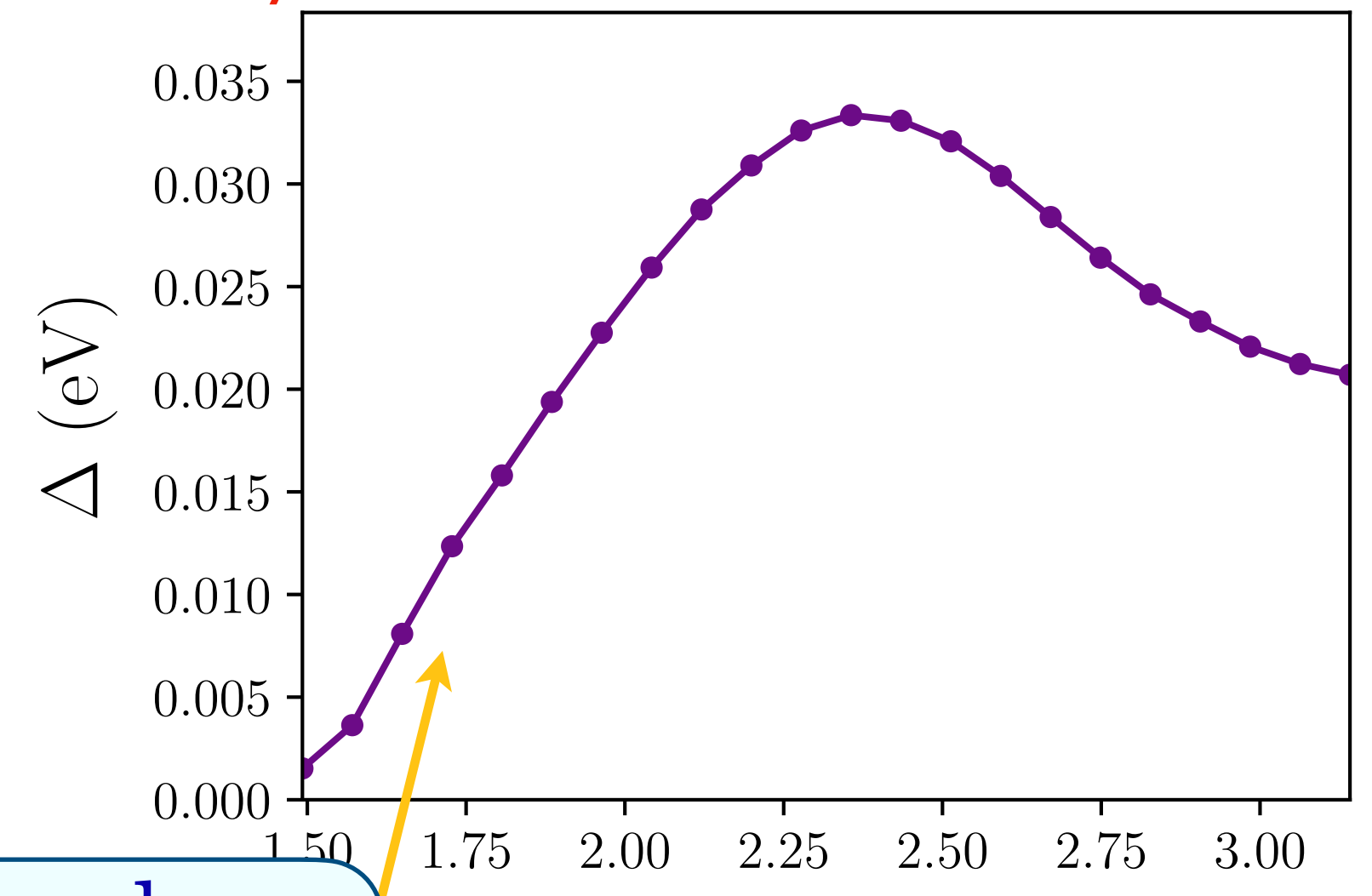
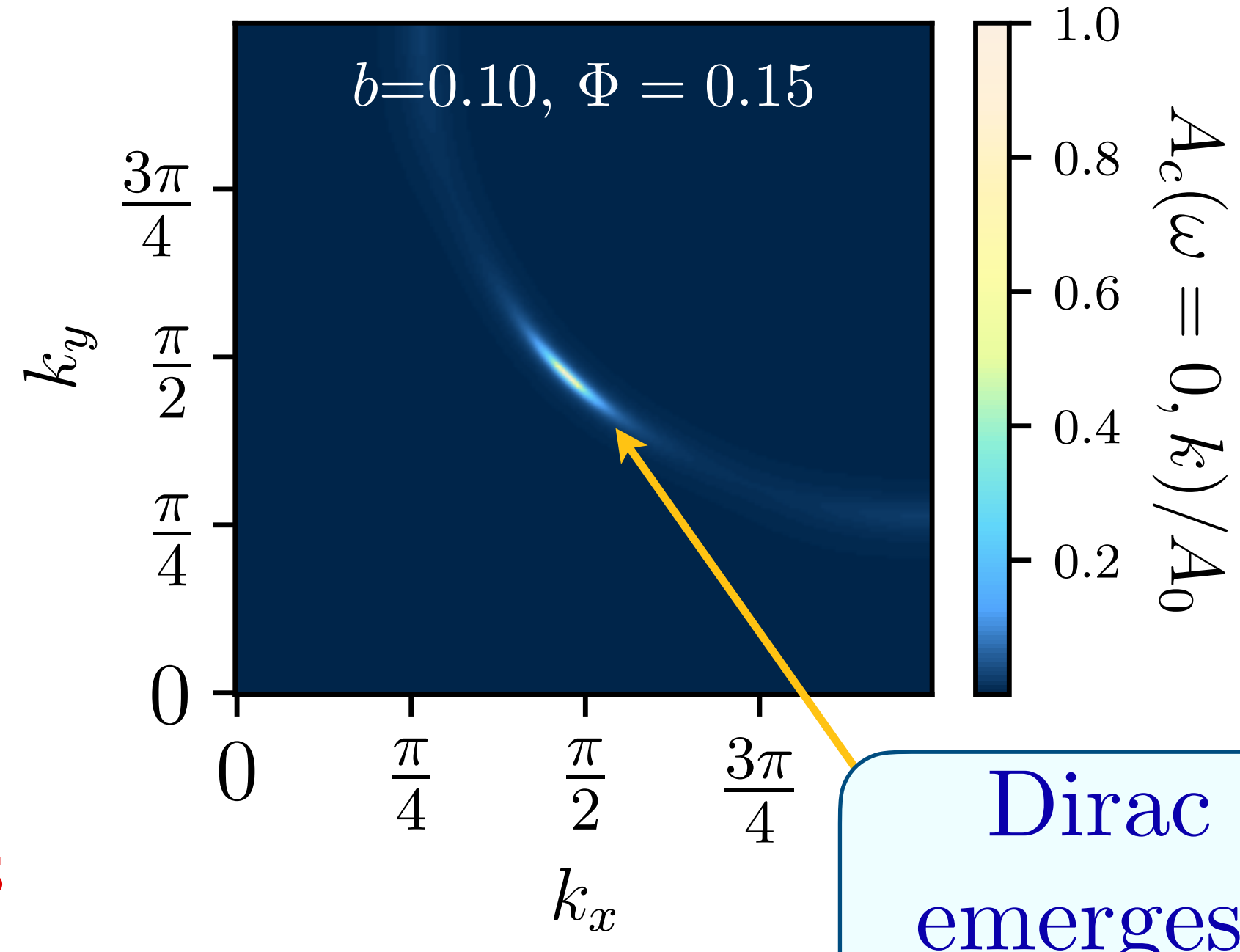

Dirac node emerges inside normal state gap

Maine Christos and S.Sachdev, arXiv:2308.03835

Ancilla theory of FL^* in a single-band model

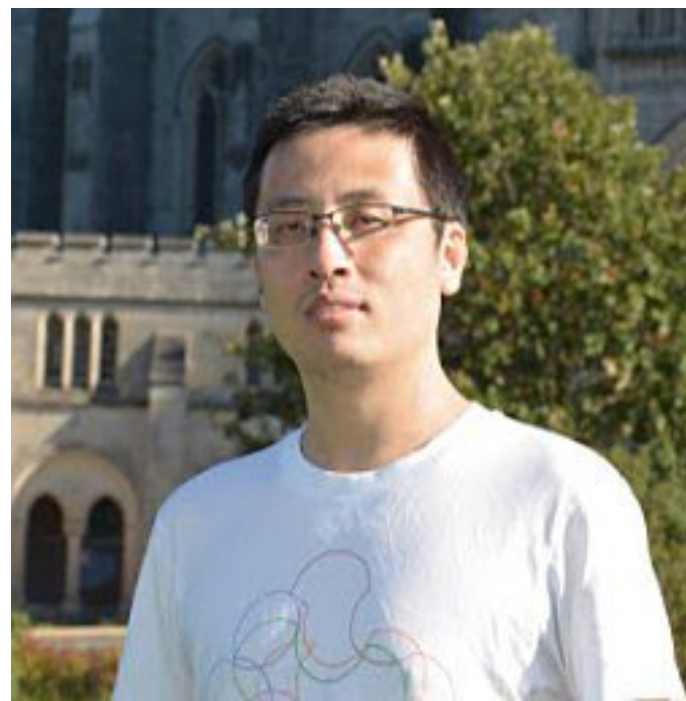

Ya-Hui Zhang

Ancilla theory of the Hubbard model

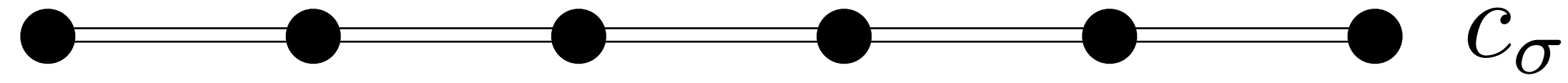

Hubbard
model of
hole density
 $1+p$

Ancilla theory of the Hubbard model

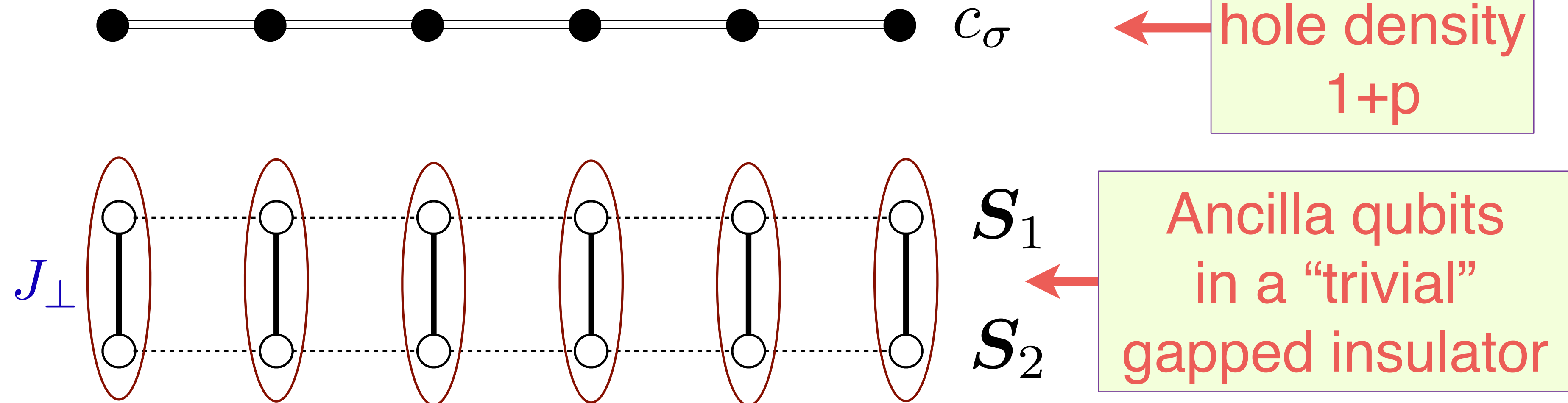

$$\mathcal{H}_{\text{Hubbard}} + \mathcal{H}_{\text{trivial insulator}}$$

Ancilla theory of the Hubbard model

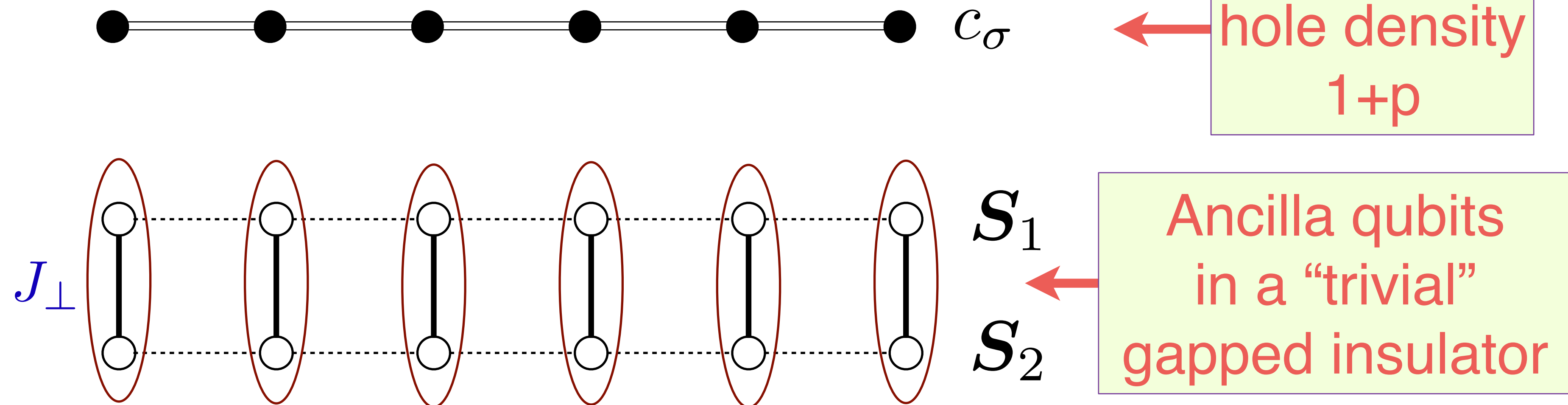

$$U (\mathcal{H}_{\text{Hubbard}} + \mathcal{H}_{\text{trivial insulator}}) U^{-1} = \mathcal{H}_{\text{ancilla}}$$

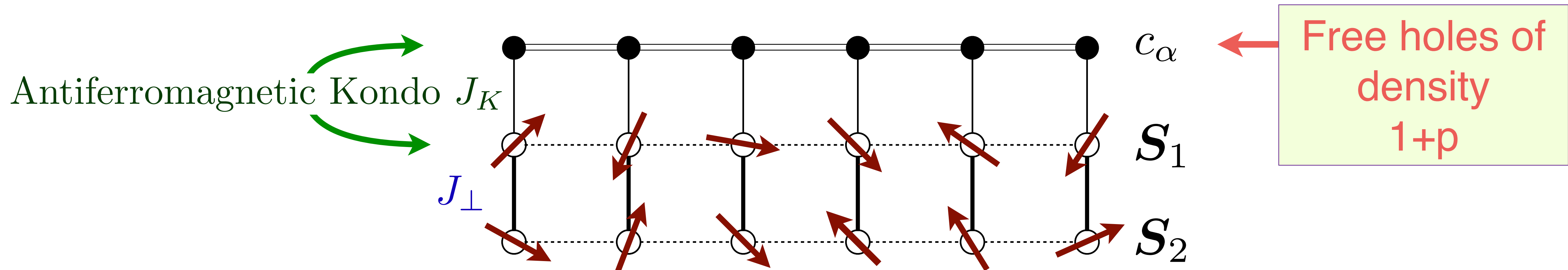

Ancilla theory of the Hubbard model

Ya-Hui Zhang and S. Sachdev,
Phys. Rev. Res. **2**, 023172 (2020)

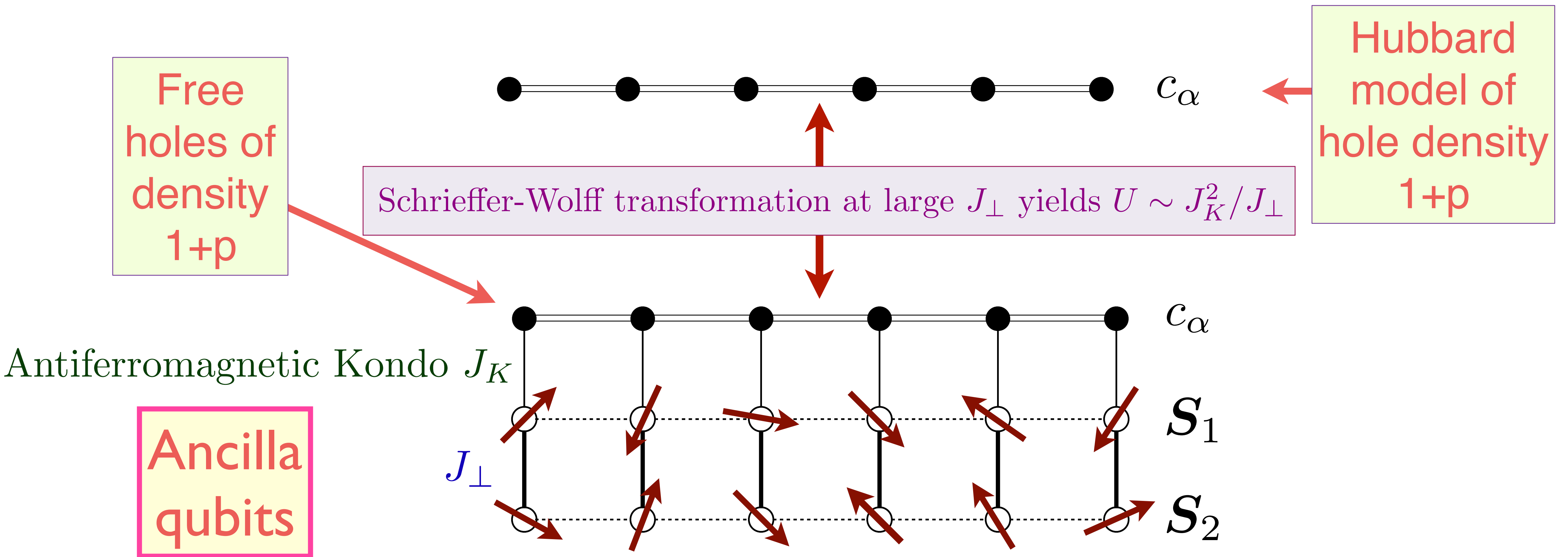

$$\mathcal{H}_{\text{ancilla}} = \sum_{\mathbf{p}} \varepsilon_{\mathbf{p}} c_{\mathbf{p}\alpha}^{\dagger} c_{\mathbf{p}\alpha} + J_K \sum_i c_{i\alpha}^{\dagger} \frac{\boldsymbol{\sigma}_{\alpha\alpha'}}{2} c_{i\alpha'} \cdot \mathbf{S}_{1i} + J_{\perp} \sum_i \mathbf{S}_{1i} \cdot \mathbf{S}_{2i}$$

Ancilla theory of the Hubbard model

Ya-Hui Zhang and S. Sachdev,
Phys. Rev. Res. **2**, 023172 (2020)

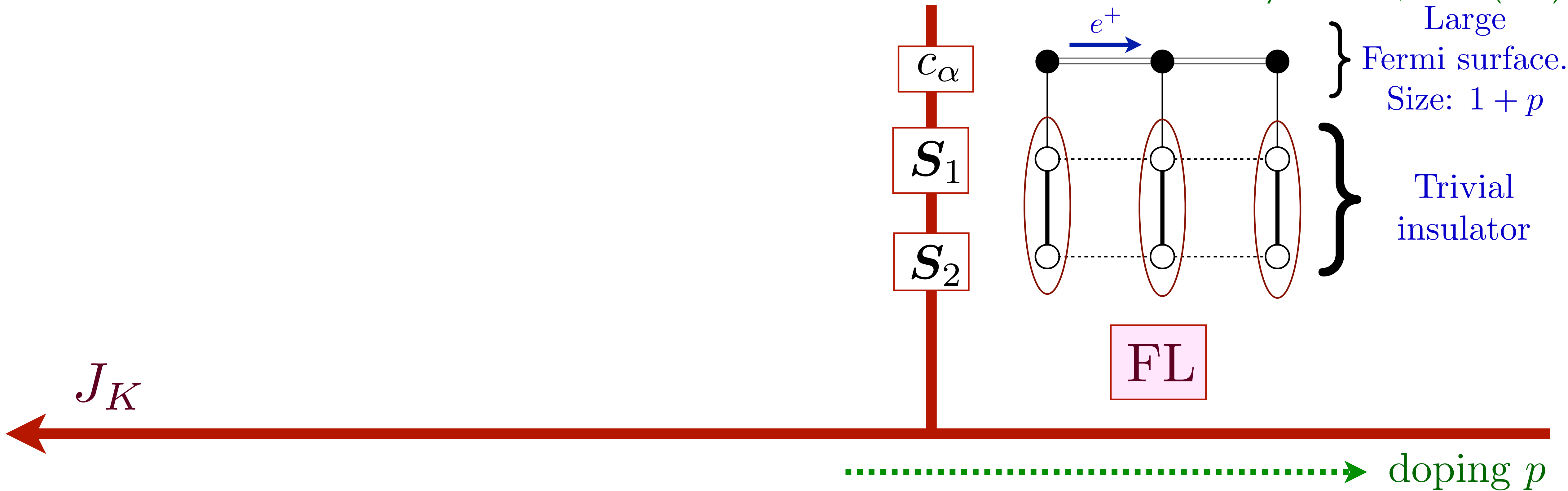

Ya-Hui
Zhang

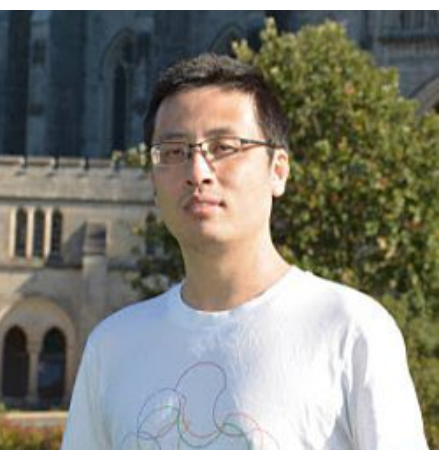

Ancilla theory of the Hubbard model

Ya-Hui Zhang and S. Sachdev,
Phys. Rev. Res. **2**, 023172 (2020)

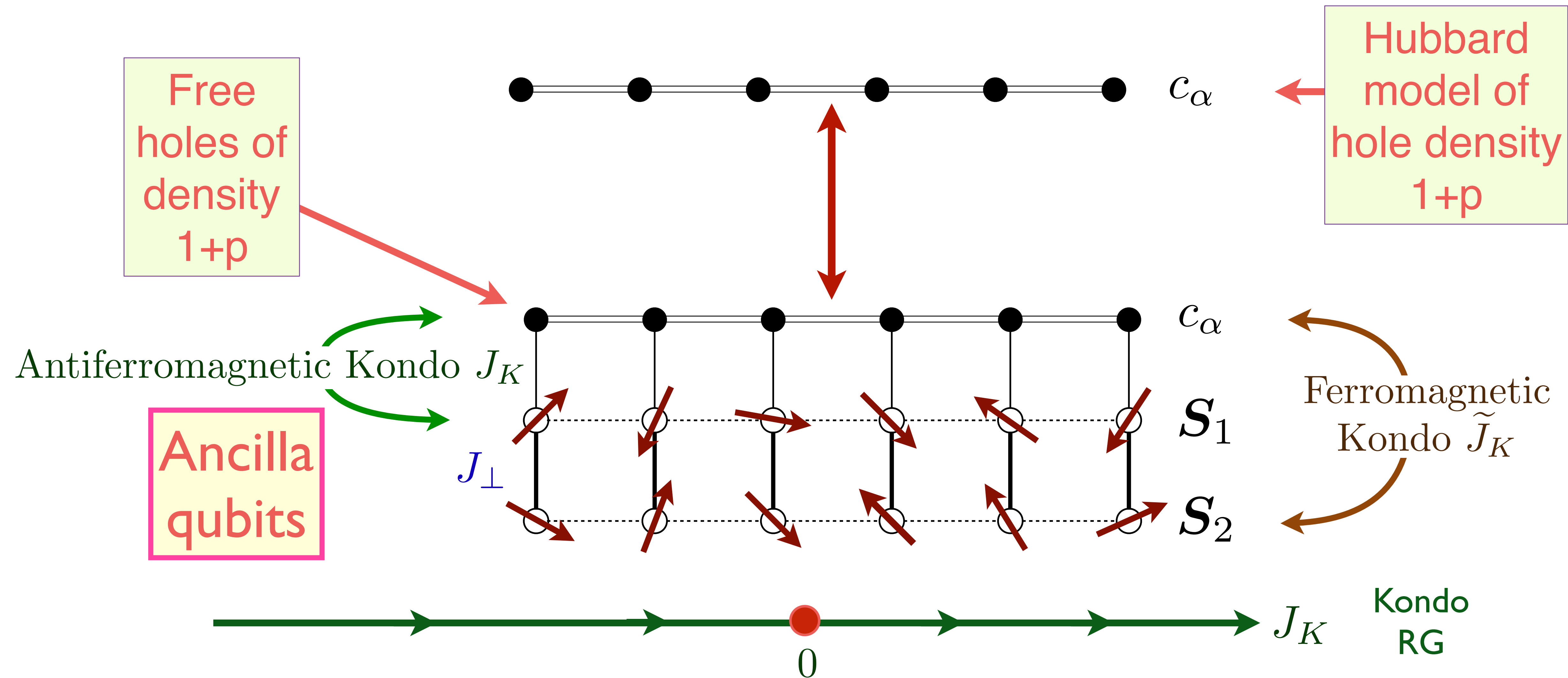

$$\mathcal{H}_{\text{ancilla}} = \sum_{\mathbf{p}} \varepsilon_{\mathbf{p}} c_{\mathbf{p}\alpha}^{\dagger} c_{\mathbf{p}\alpha} + J_K \sum_i c_{i\alpha}^{\dagger} \frac{\sigma_{\alpha\alpha'}}{2} c_{i\alpha'} \cdot \mathbf{S}_{1i} + J_{\perp} \sum_i \mathbf{S}_{1i} \cdot \mathbf{S}_{2i}$$

Ancilla theory of the Hubbard model

Ya-Hui Zhang and S. Sachdev,
Phys. Rev. Res. **2**, 023172 (2020)

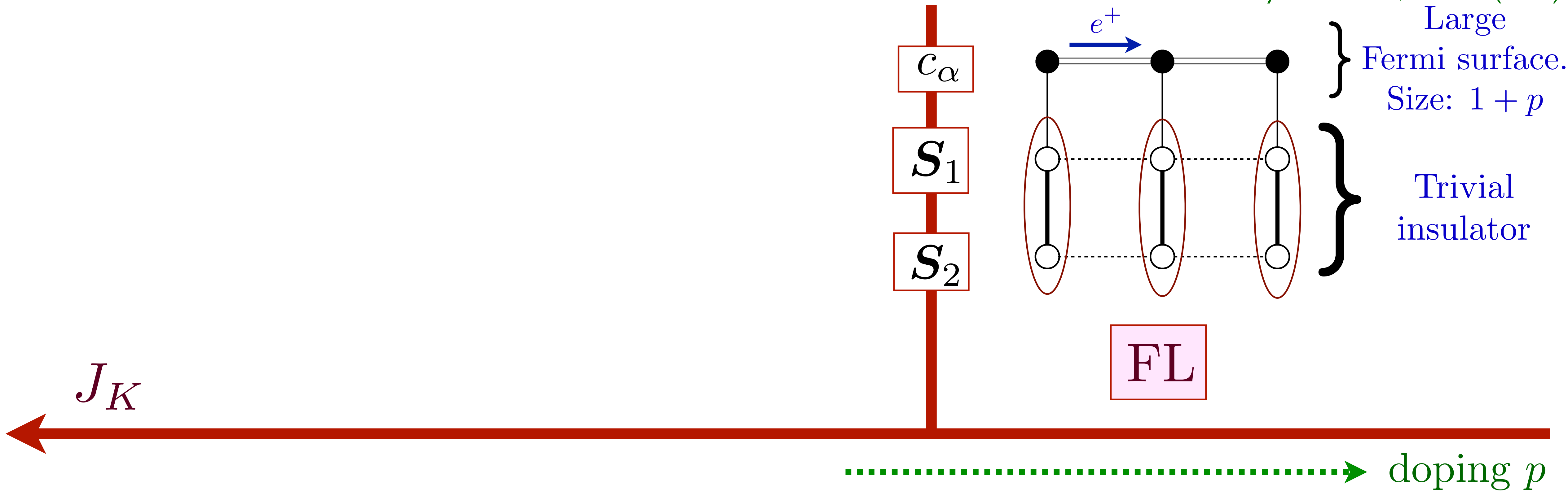

Ya-Hui
Zhang

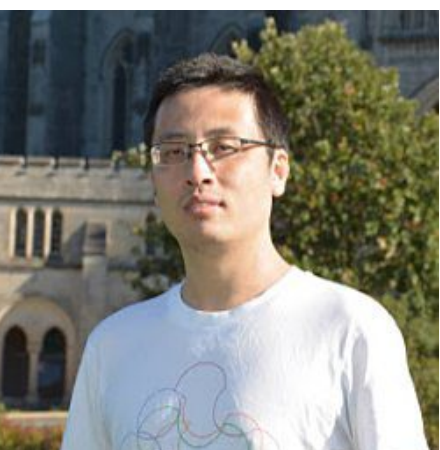

Ancilla theory of the Hubbard model

Ya-Hui Zhang and S. Sachdev,
Phys. Rev. Res. **2**, 023172 (2020)

Kondo lattice
 heavy Fermi liquid.
 Size $1 + p + 1$
 $= p \pmod{2}$.
Small Fermi surface!

Spin liquid

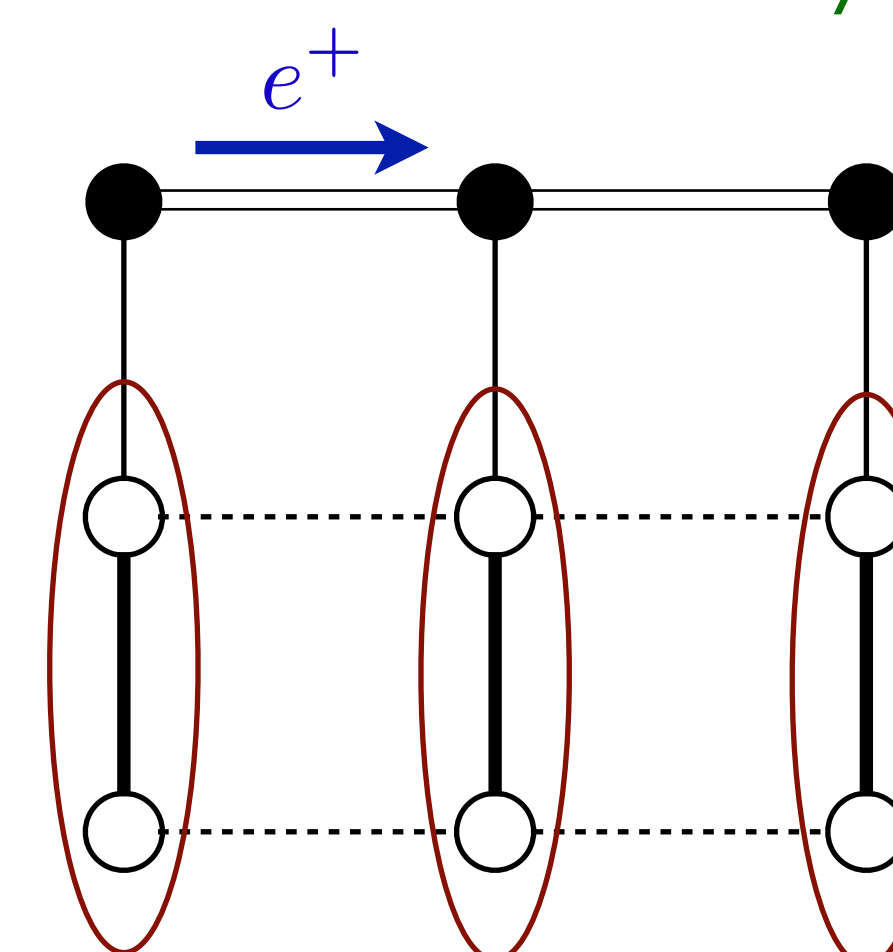
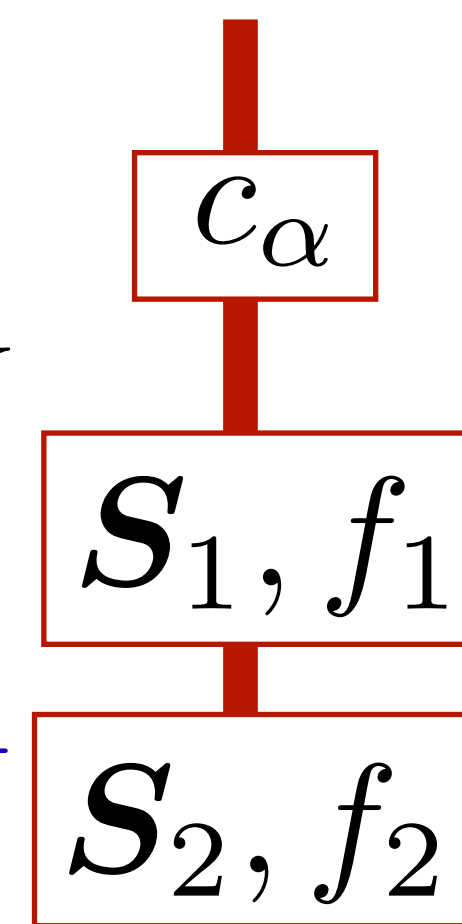
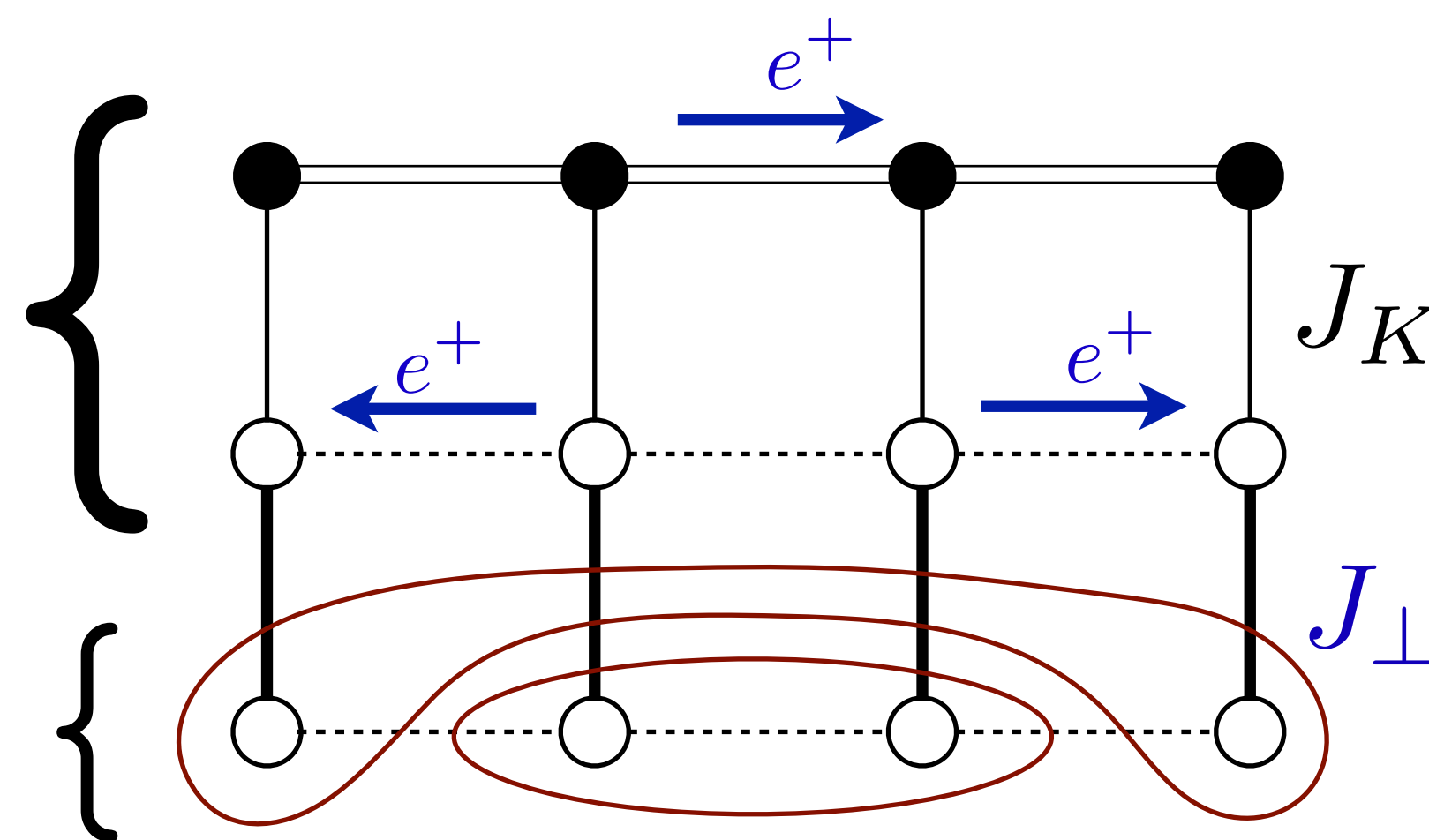

Large
 Fermi surface.
 Size: $1 + p$

Trivial
 insulator

FL*

FL

J_K

doping p

Pseudogap metal =
 Kondo Lattice Heavy
 Fermi Liquid
 \oplus
 Spin Liquid

Ya-Hui
 Zhang

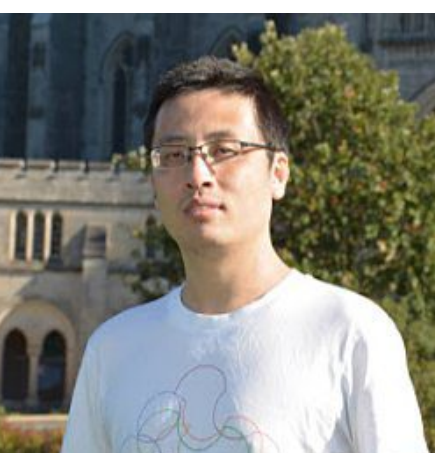

Ancilla theory of the Hubbard model

Ya-Hui Zhang and S. Sachdev,
Phys. Rev. Res. **2**, 023172 (2020)

Kondo lattice
 heavy Fermi liquid.
 Size $1 + p + 1$
 $= p \pmod{2}$.
Small Fermi surface!

Spin liquid

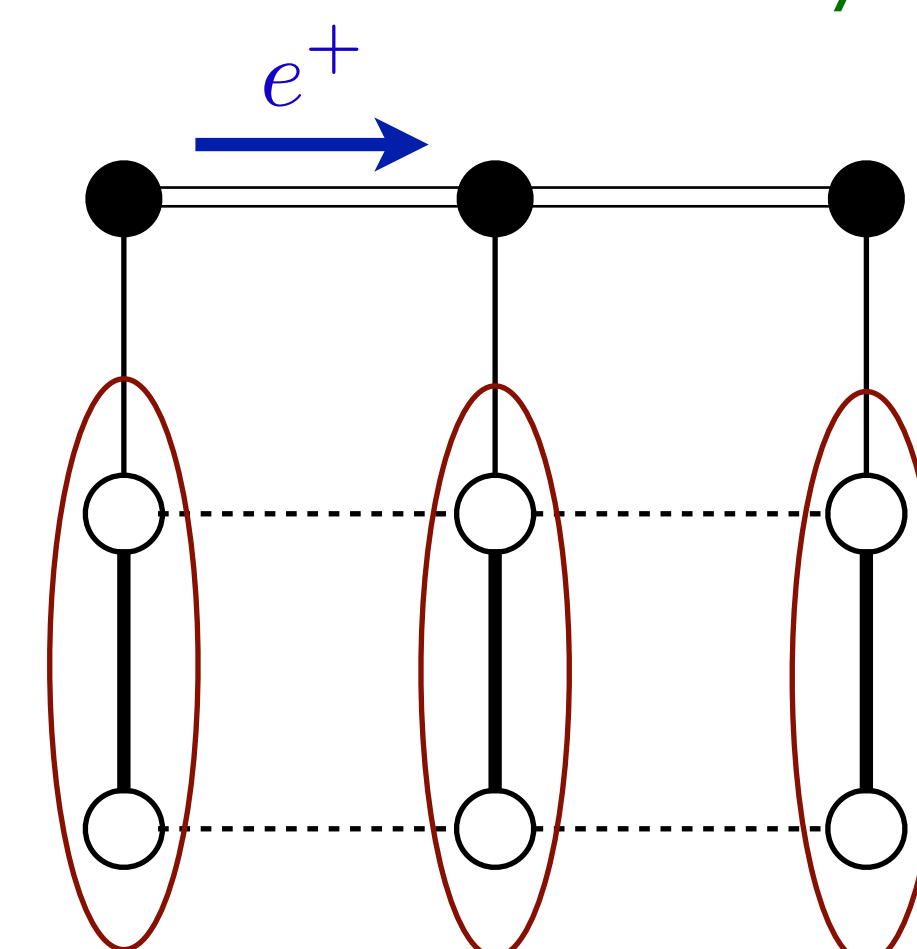
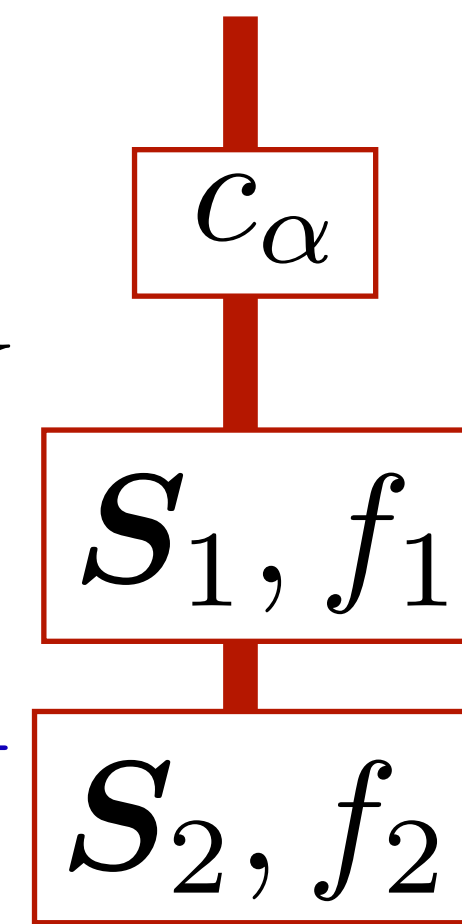
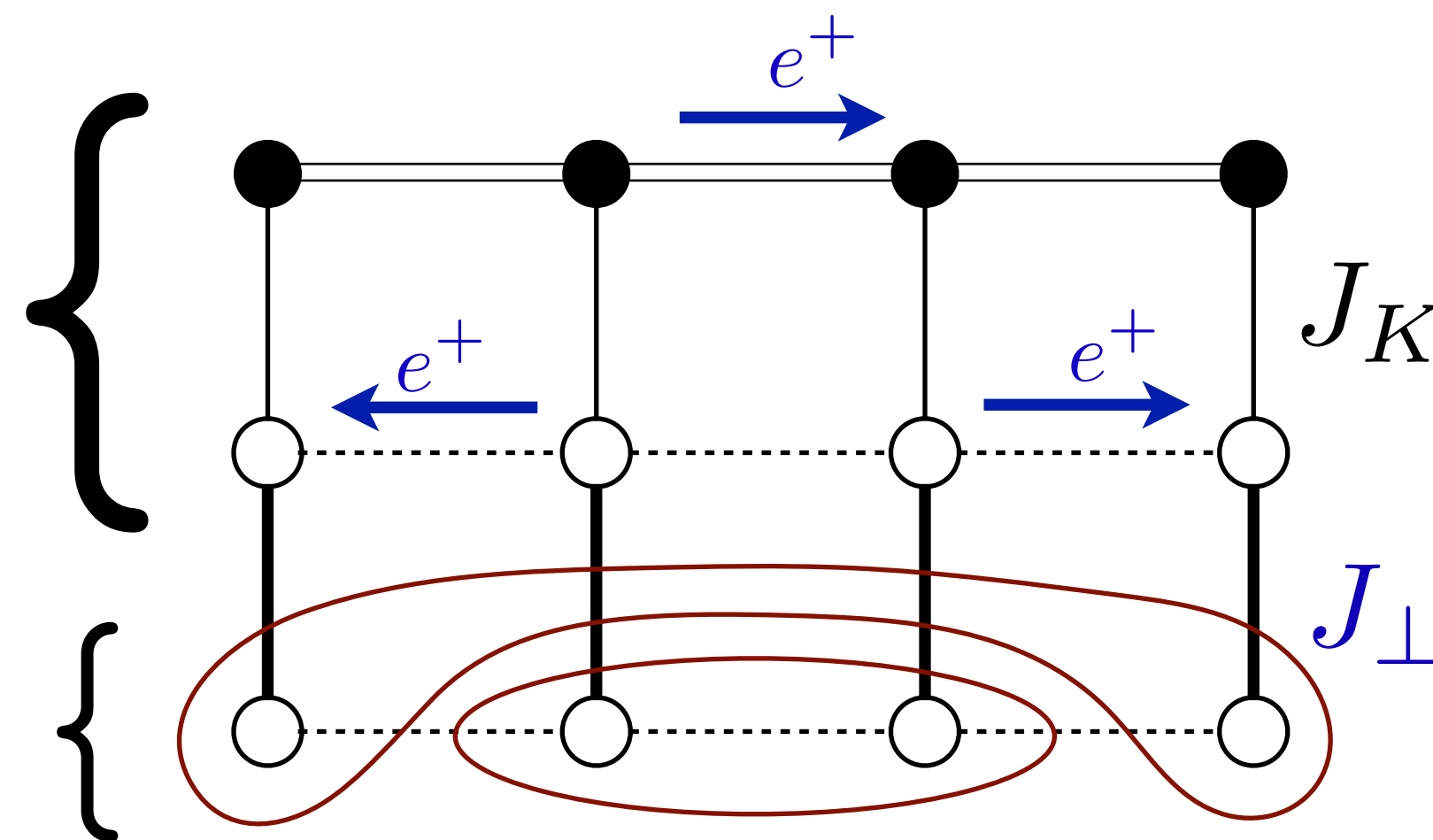

Large
 Fermi surface.
 Size: $1 + p$

Trivial
 insulator

FL*

FL

J_K

doping p

Pseudogap metal =
 Kondo Lattice Heavy
 Fermi Liquid
 \oplus
 Spin Liquid

$$|\text{FL}^*\rangle = [\text{Projection onto rung singlets of } \mathcal{S}_1, \mathcal{S}_2] \\
\otimes |\text{Slater determinant of } (c, f_1)\rangle \\
\otimes |\text{Spin liquid of } \mathcal{S}_2\rangle$$

Replacement for “vanilla” Gutzwiller-projected Fermi liquid in the underdoped regime

Ya-Hui
 Zhang

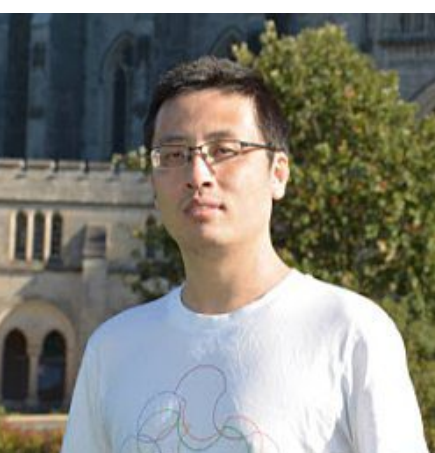

**Connections
to experiments**

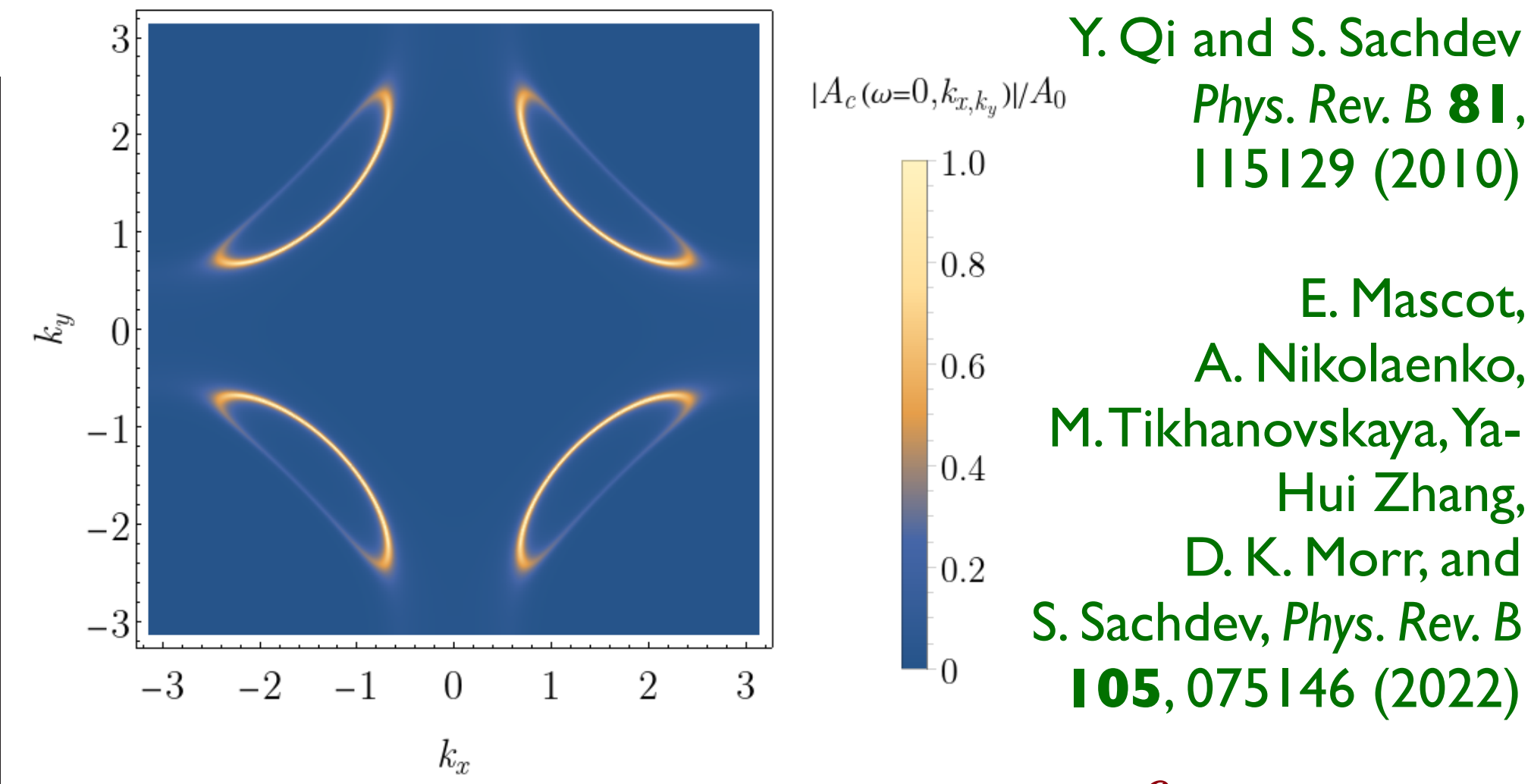
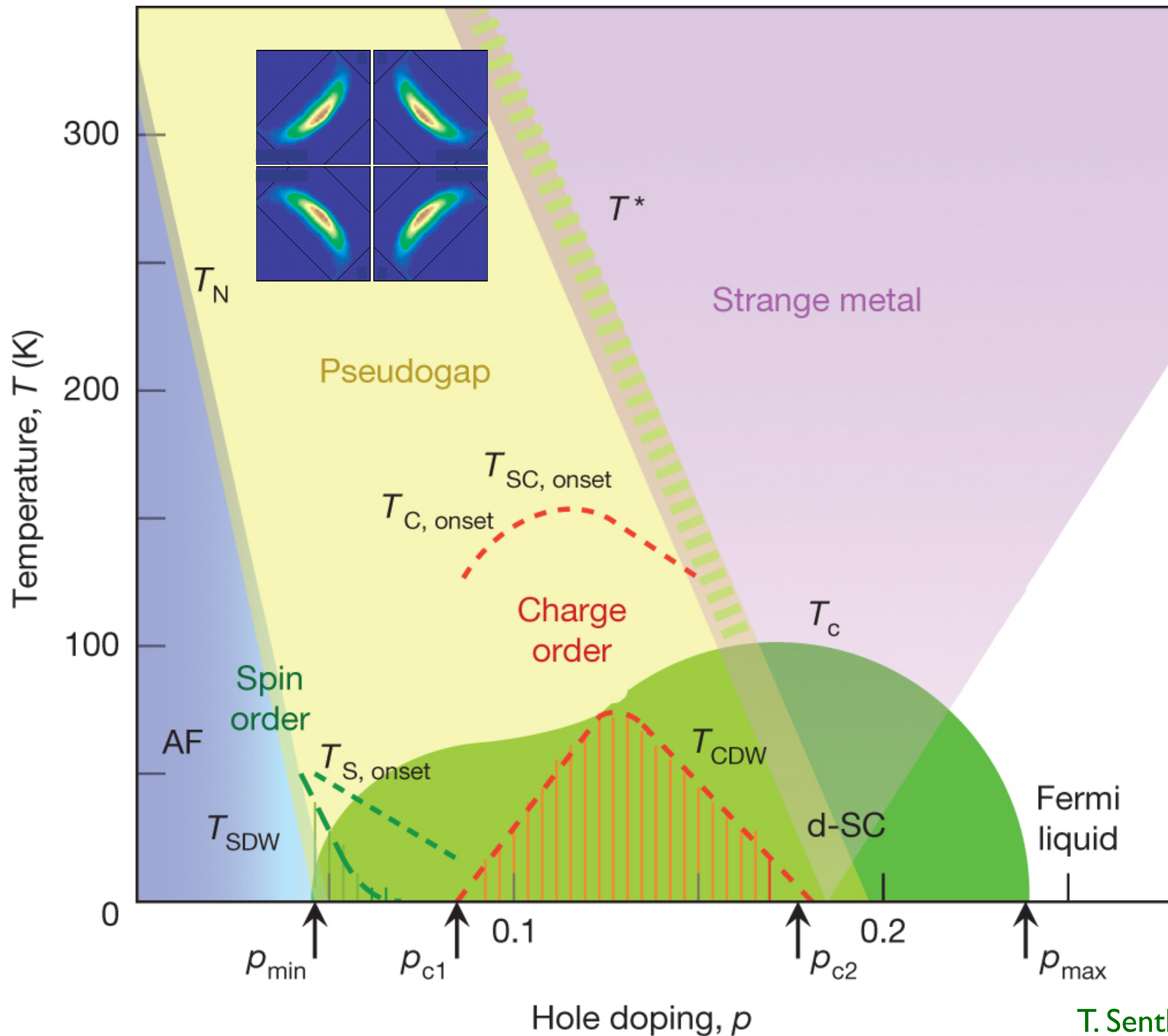

Hole pocket Fermi surfaces
of size p with
charge e , spin-1/2 quasiparticles
+
'spectator'
square lattice spin liquid
at half-filling.

FL*: Spin liquid is *required* because
the Fermi surface does not enclose
the Luttinger volume $(1 + p)$.

FL* in a one-band model

Broadening by second ancilla layer is needed to describe MDC and EDC

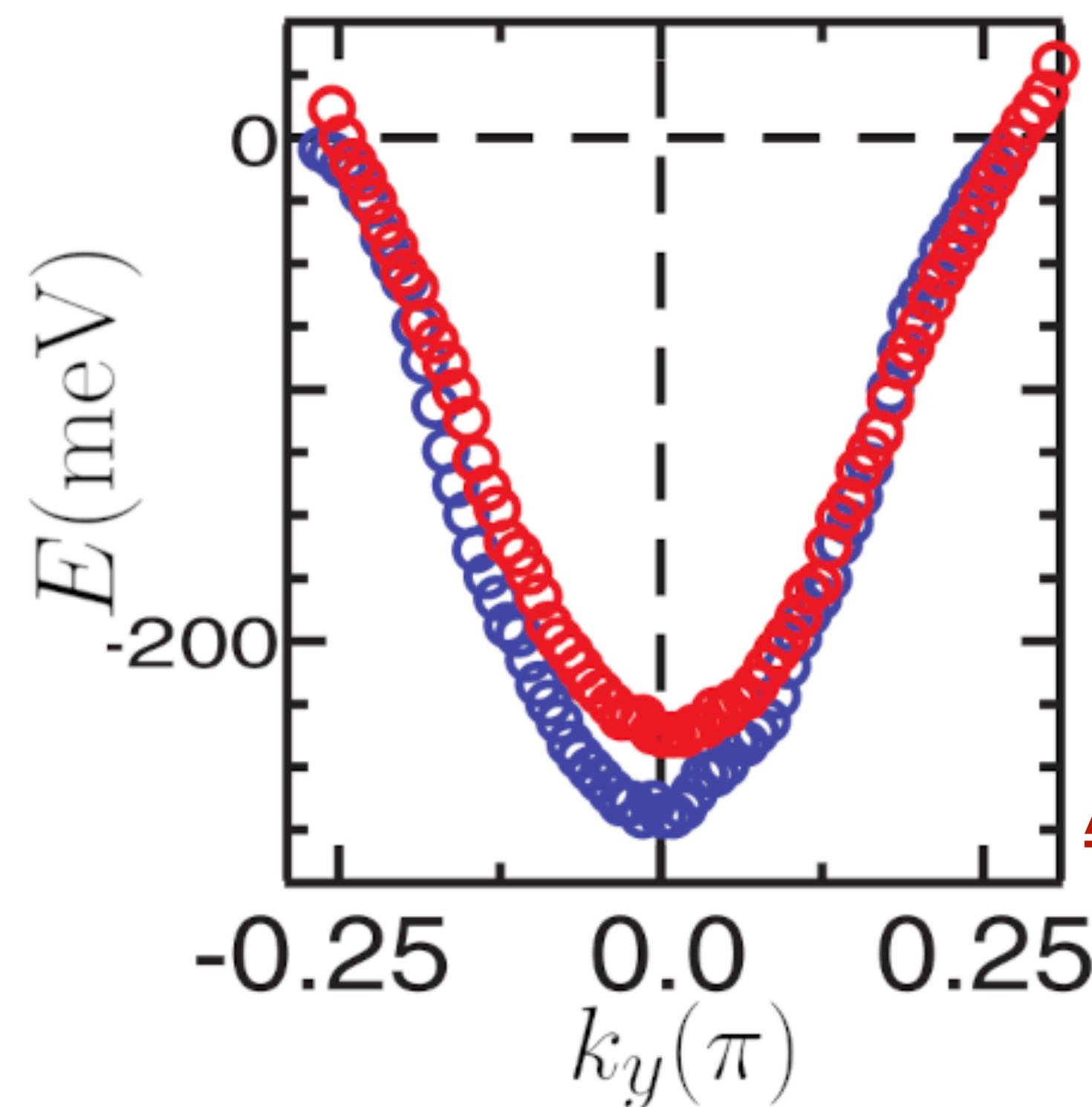
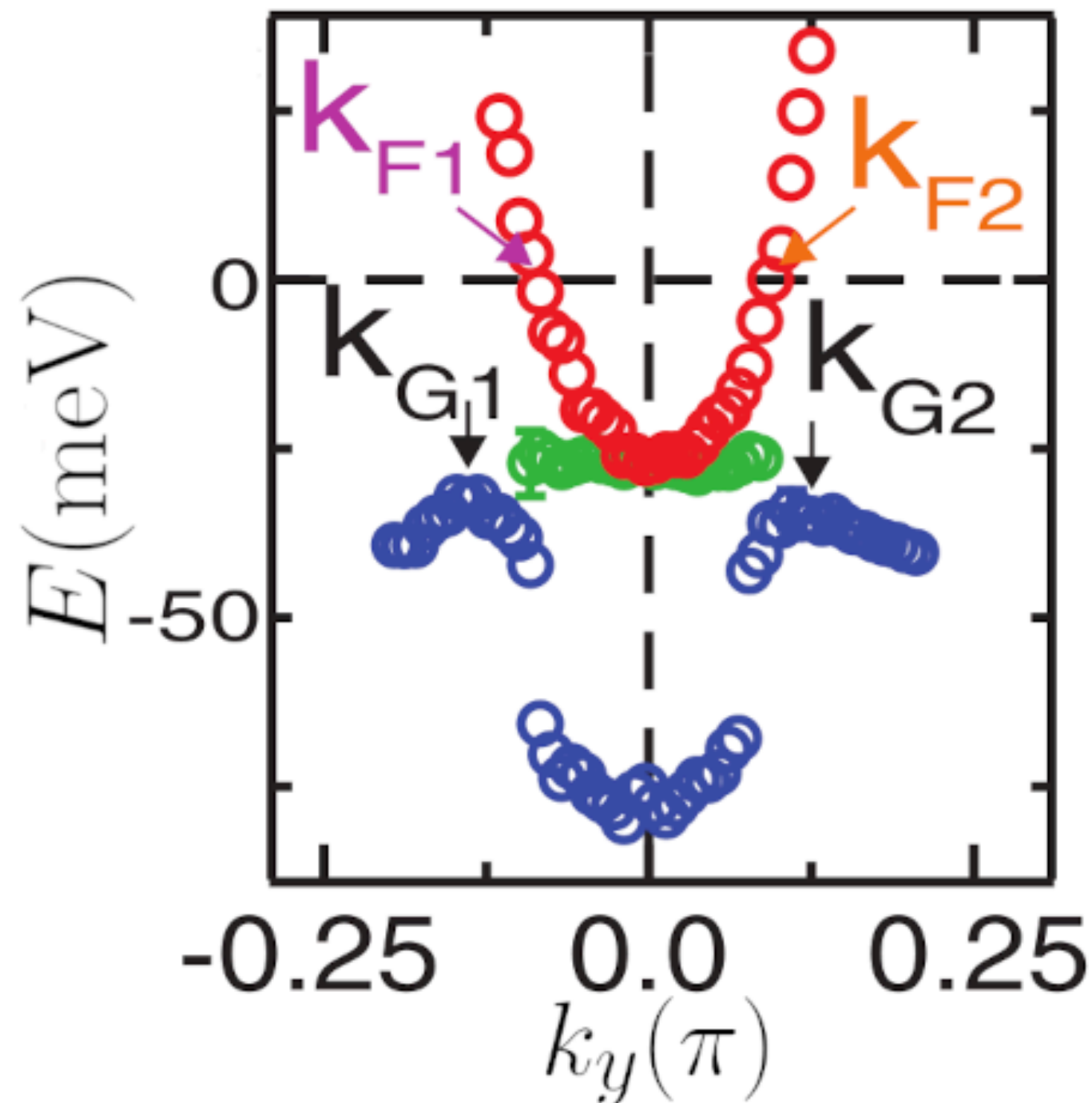
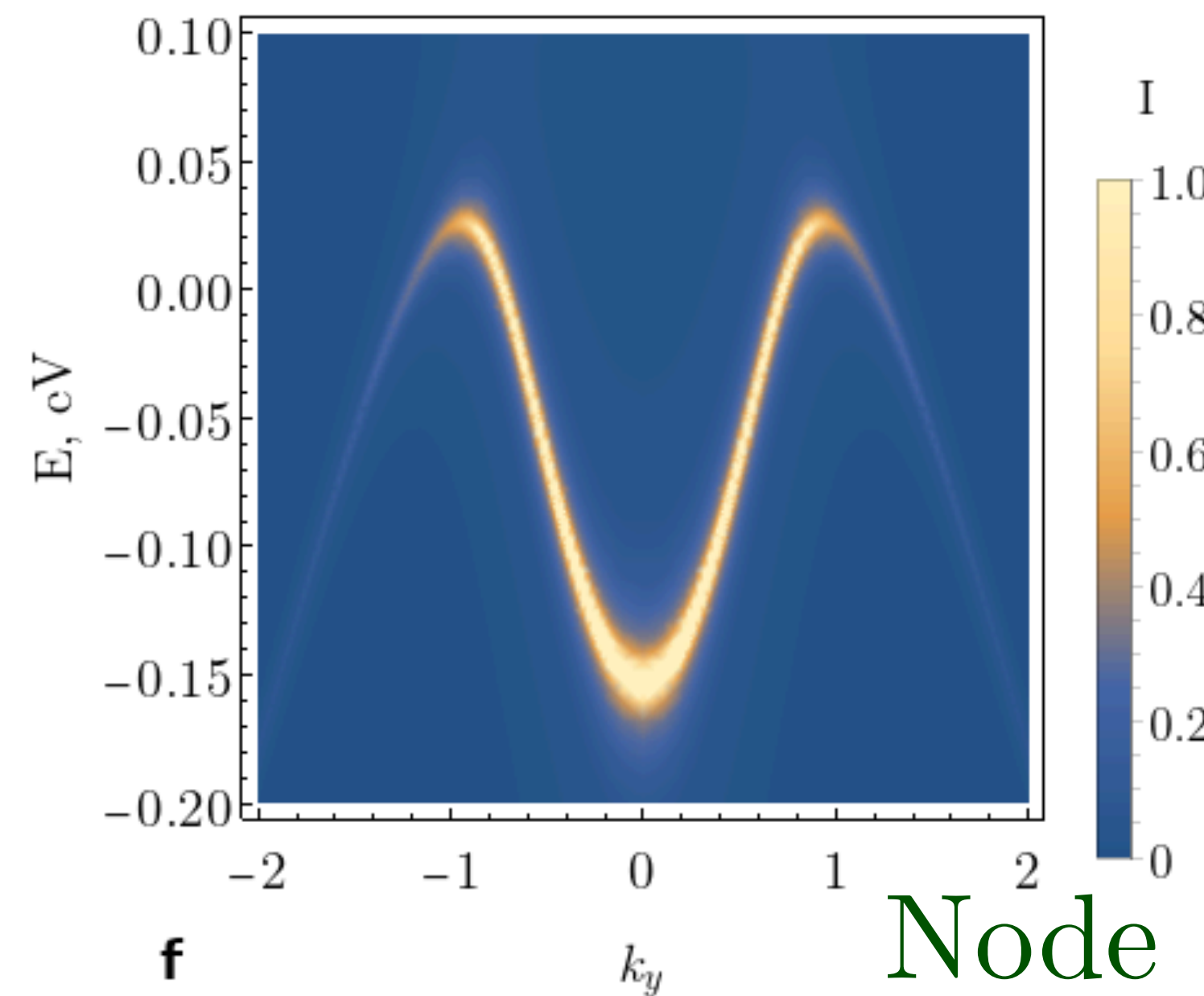
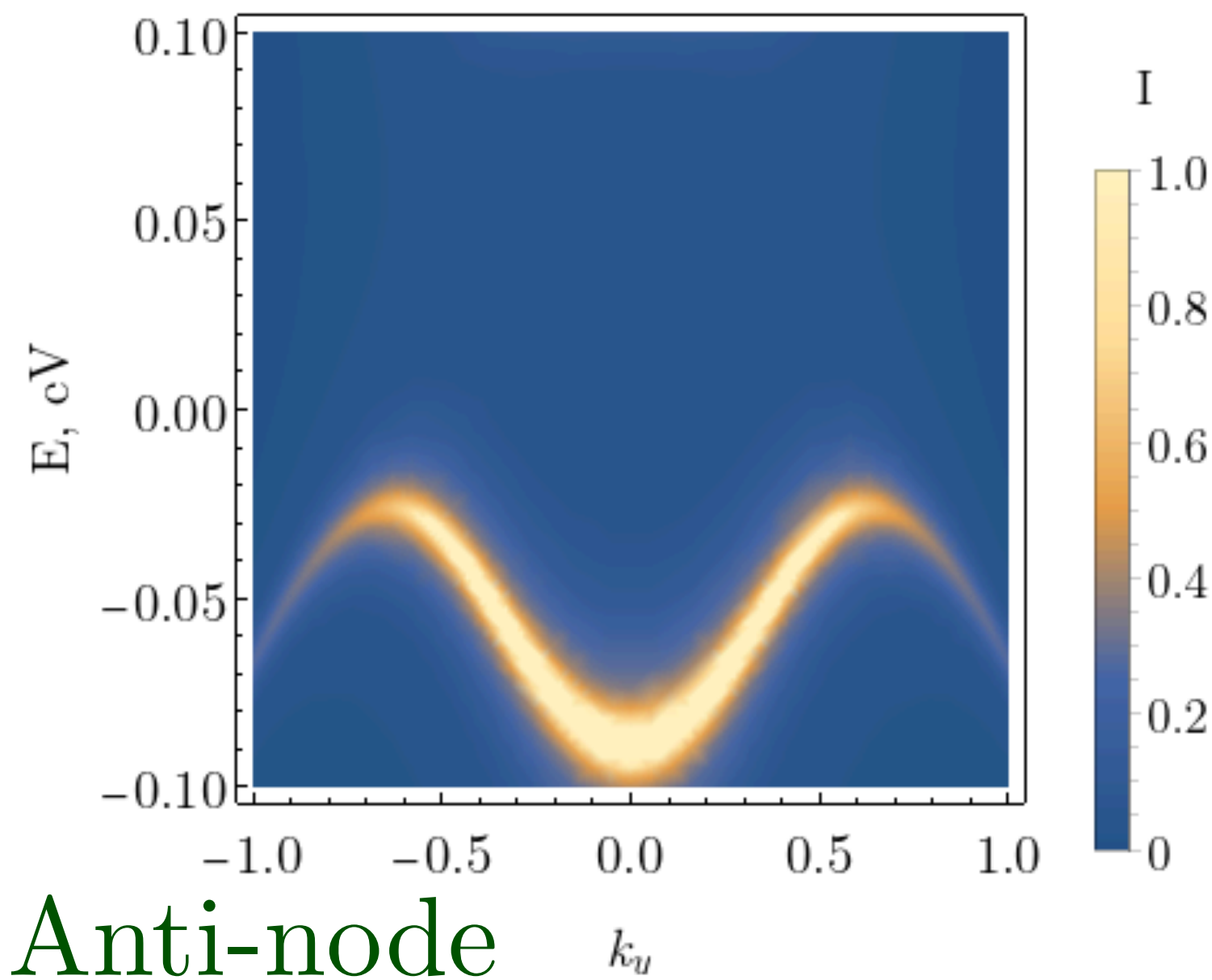

He, Hashimoto, Karapetyan, Koralek, Hinton, Testaud, Nathan, Yoshida, Yao, Tanaka, Meevasana, Moore, Lu, Mo, Ishikado, Eisaki, Hussain, Devereaux, Kivelson, Orenstein, Kapitulnik, and Shen, *Science* **331**, 1579 (2011)

ARPES on
Bi2201



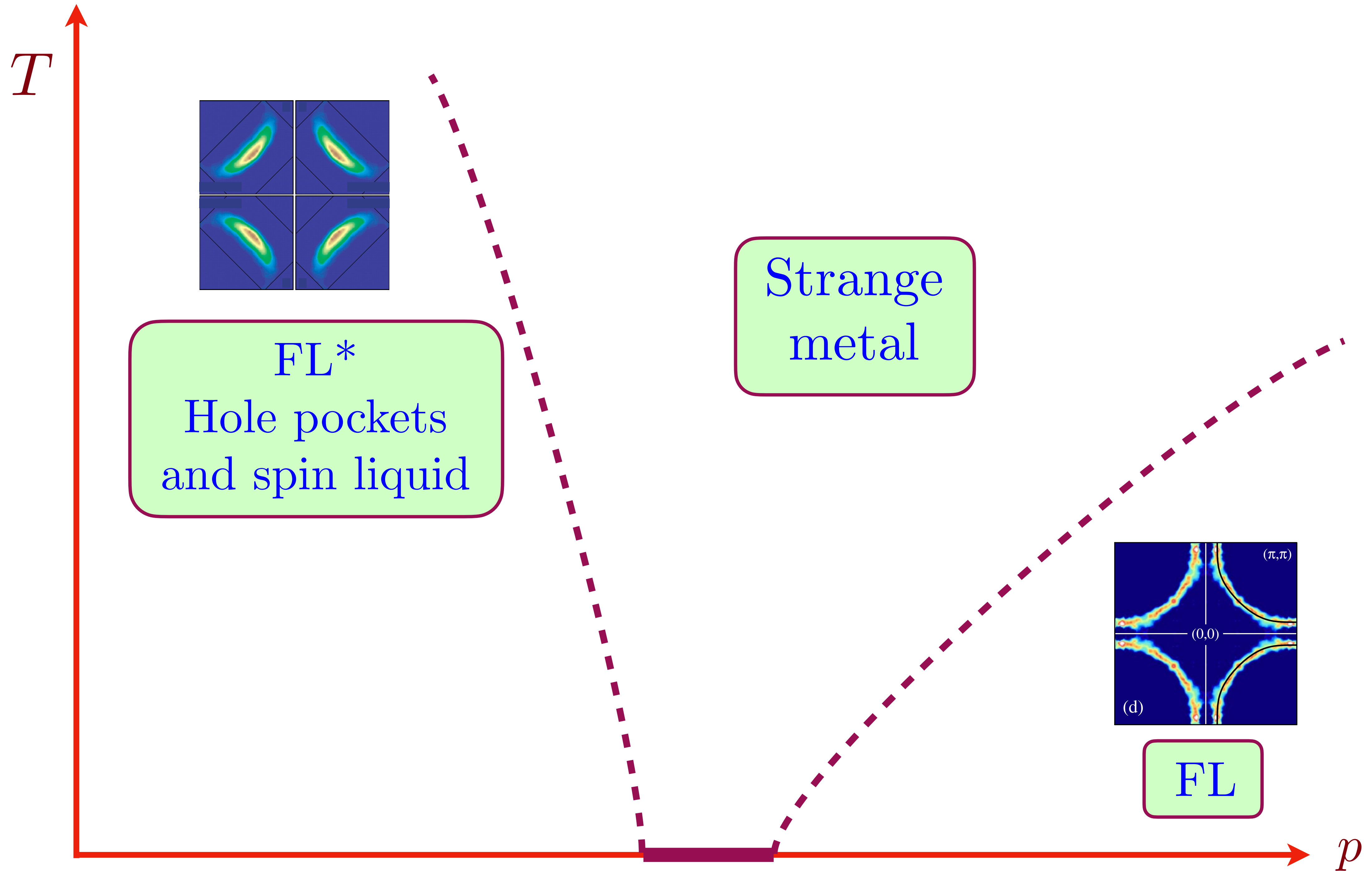

T

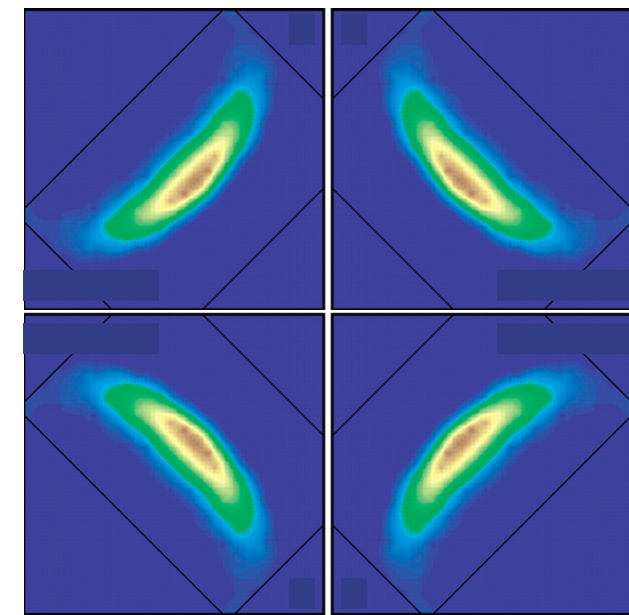

FL^*
Hole pockets
and spin liquid

Strange
metal

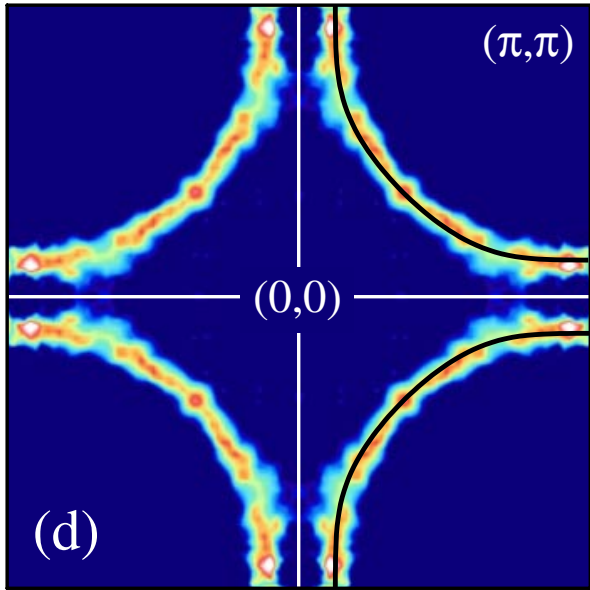

FL

p

T

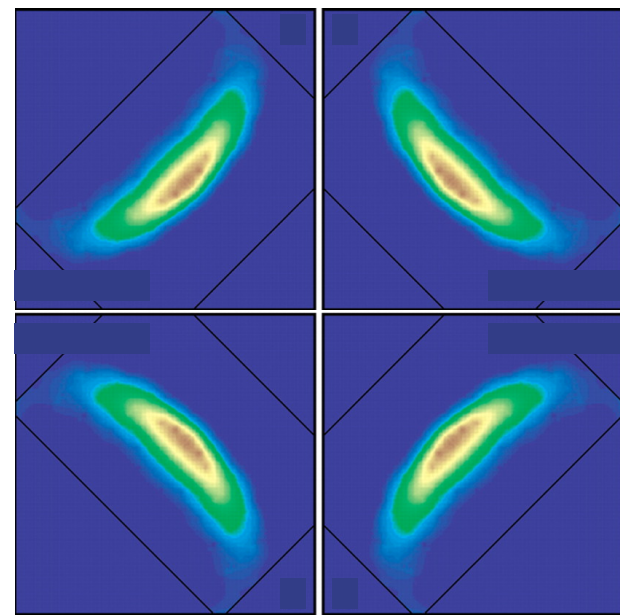

FL*
Hole pockets
and spin liquid

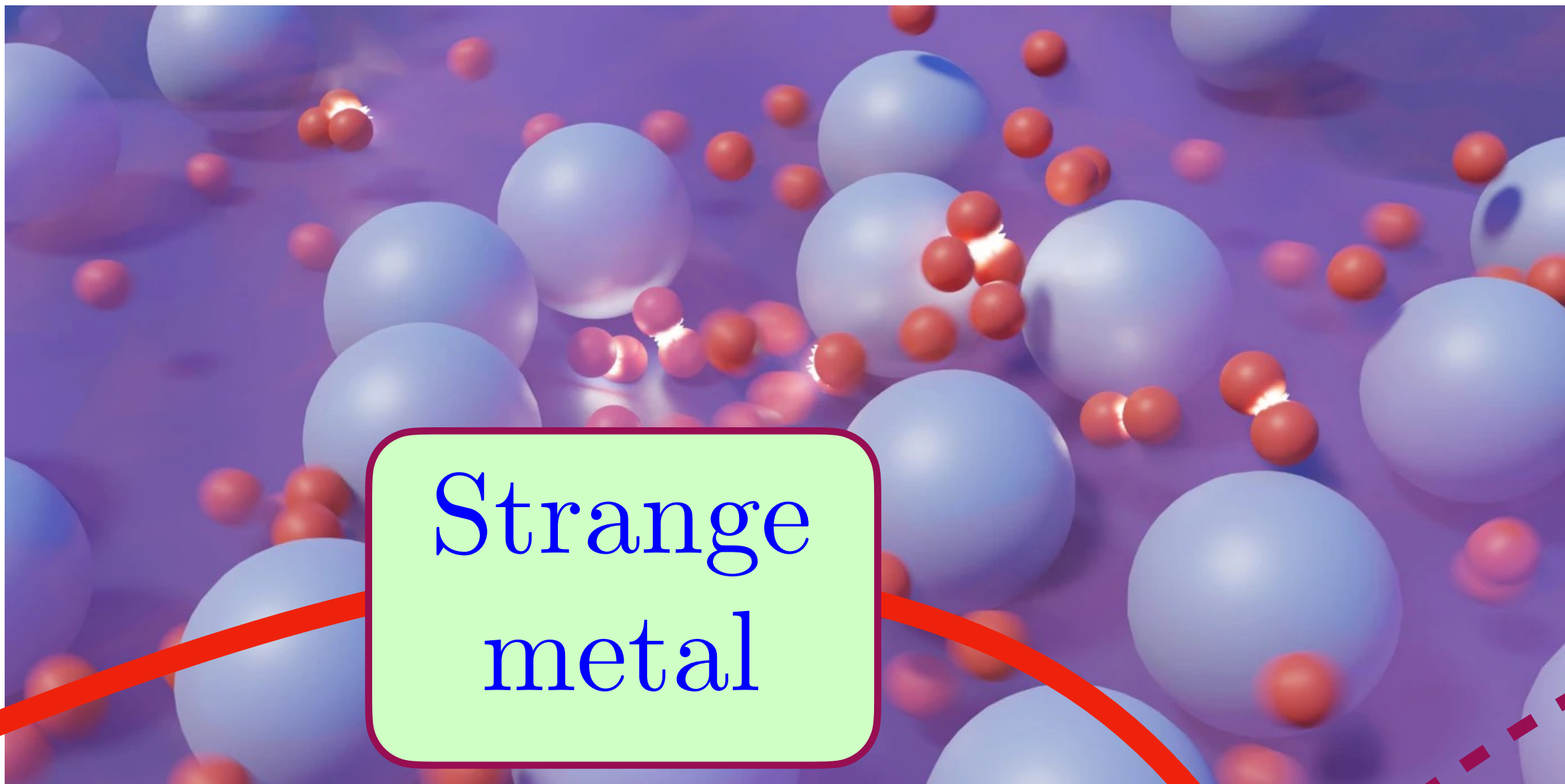

Strange
metal

$SU(2)_s \times U(1)_a$ gauge theory
in ancilla model
with Higgs field $H_{\alpha a} \sim c_{\alpha}^{\dagger} f_{1a}$

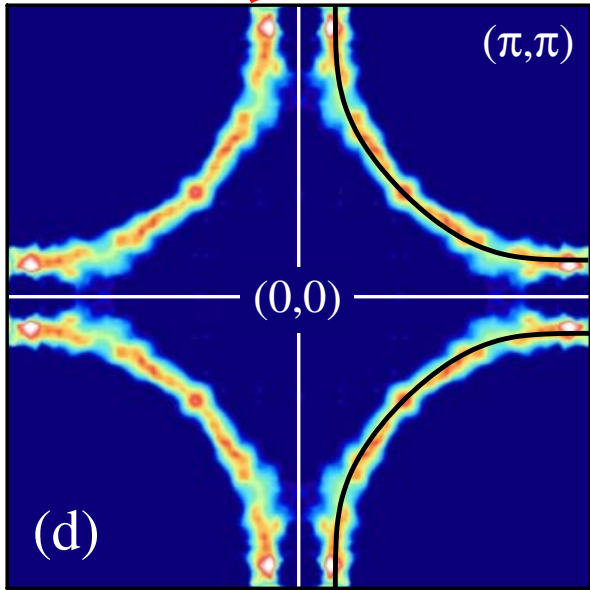

FL

Patel,
Haoyu
Guo,
Esterlis,
Sachdev,
Science
381, 790
(2023)

p

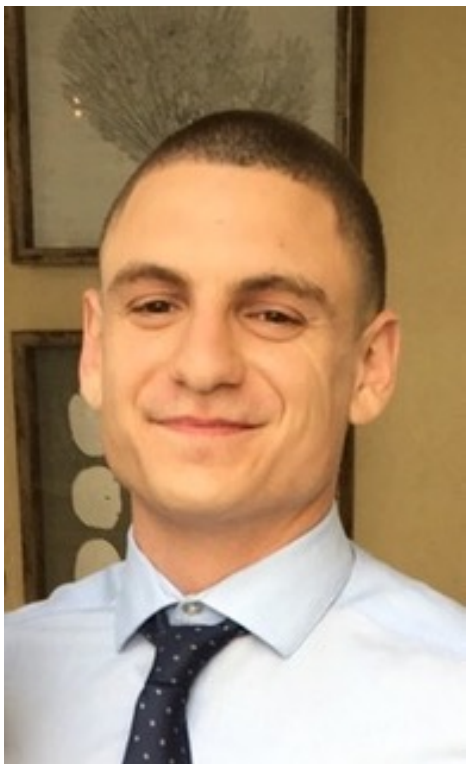

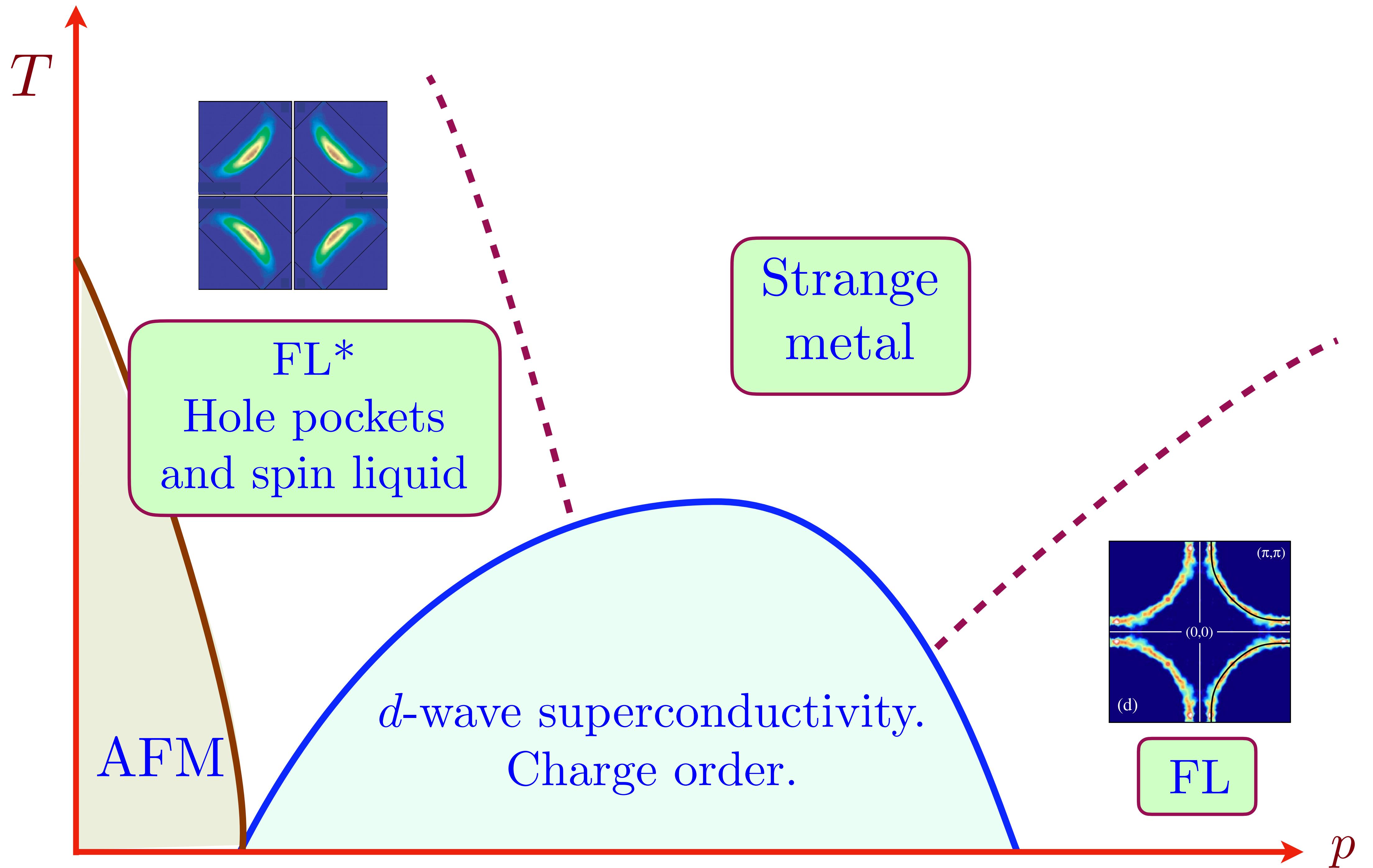

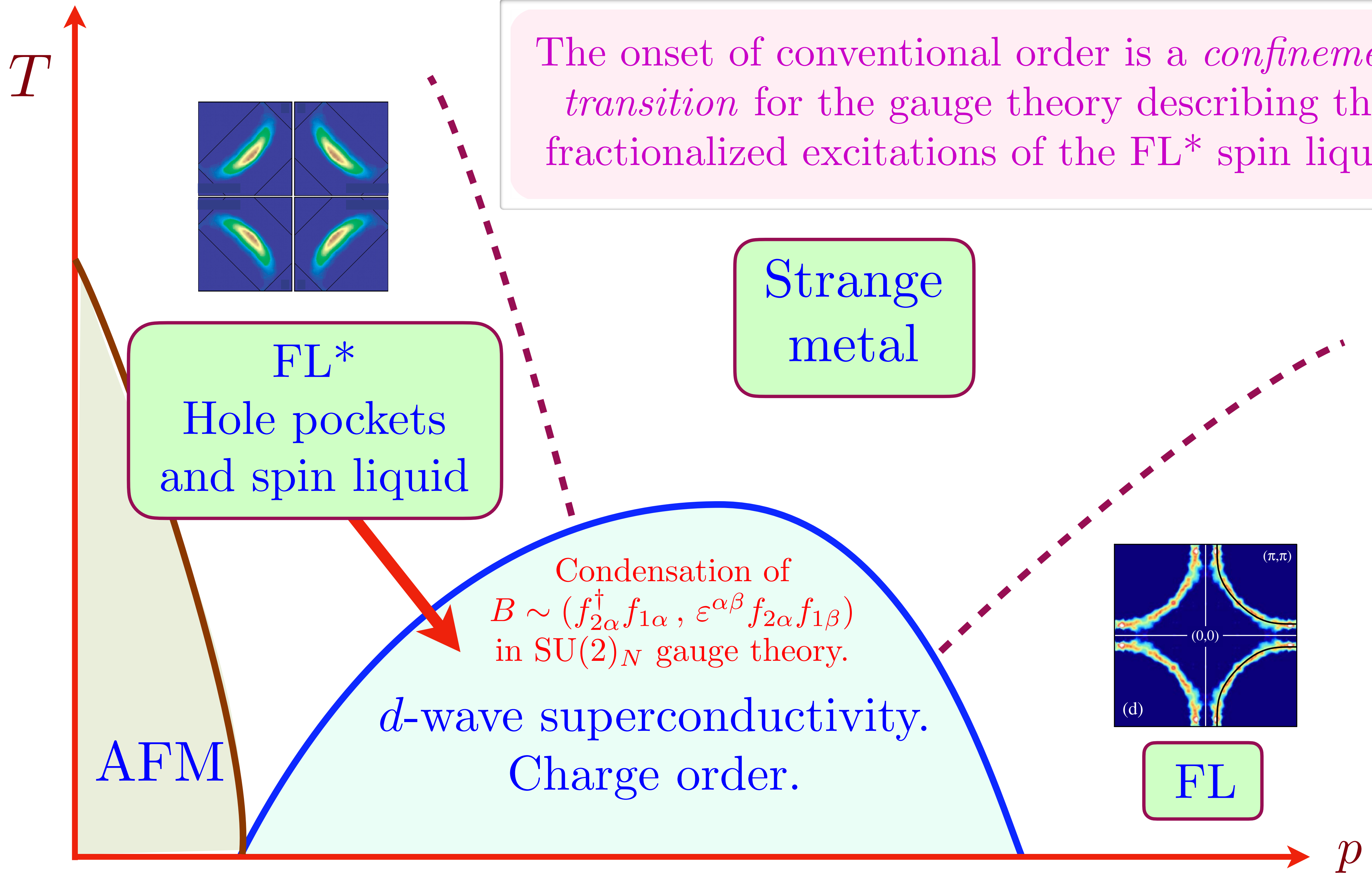

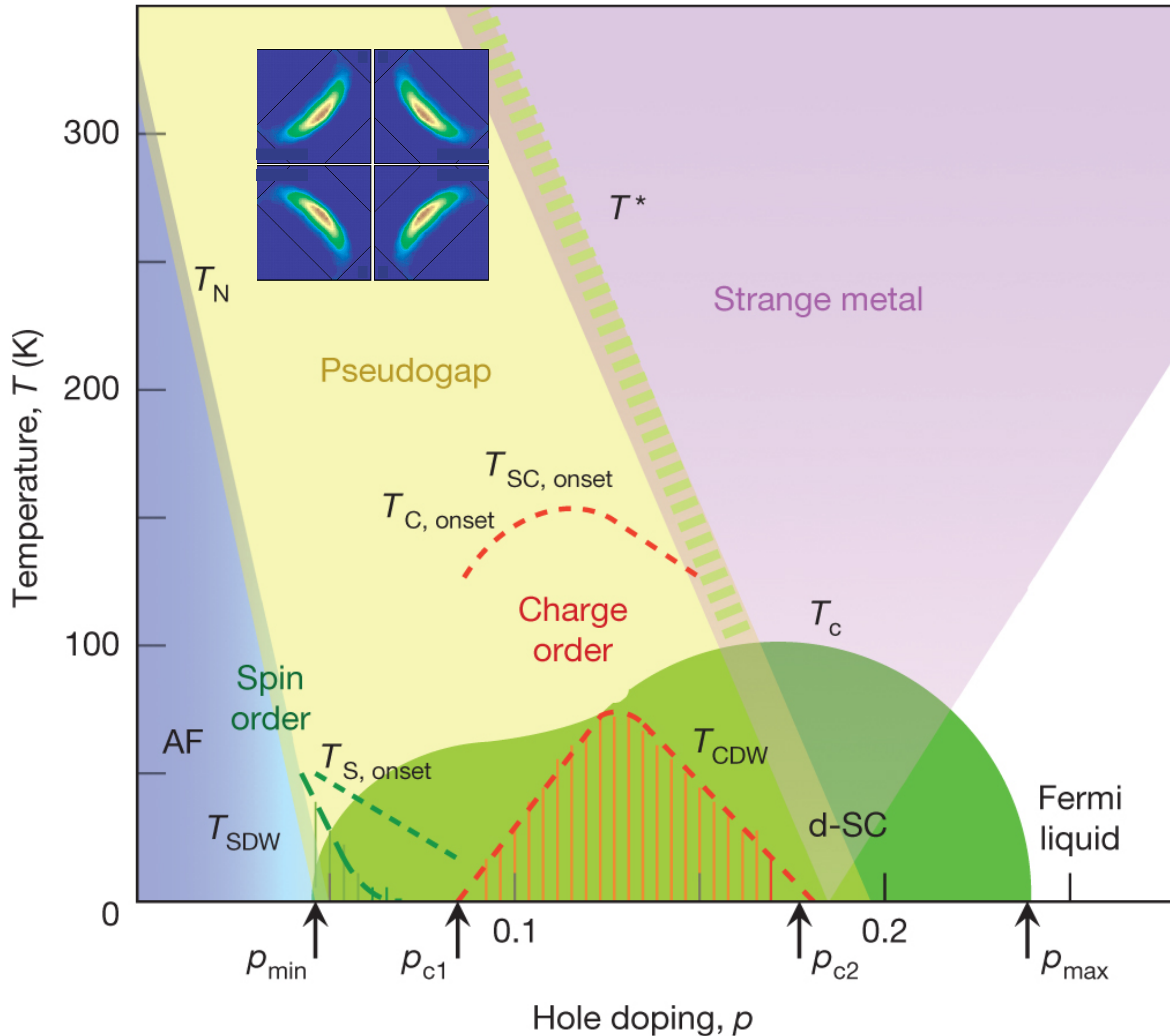

Emergent symmetry of the charge- e , $SU(2)$ fundamental boson effective theory of the π -flux state provides a rationale for the near equality of the onset temperatures of d -wave superconductivity and charge order.

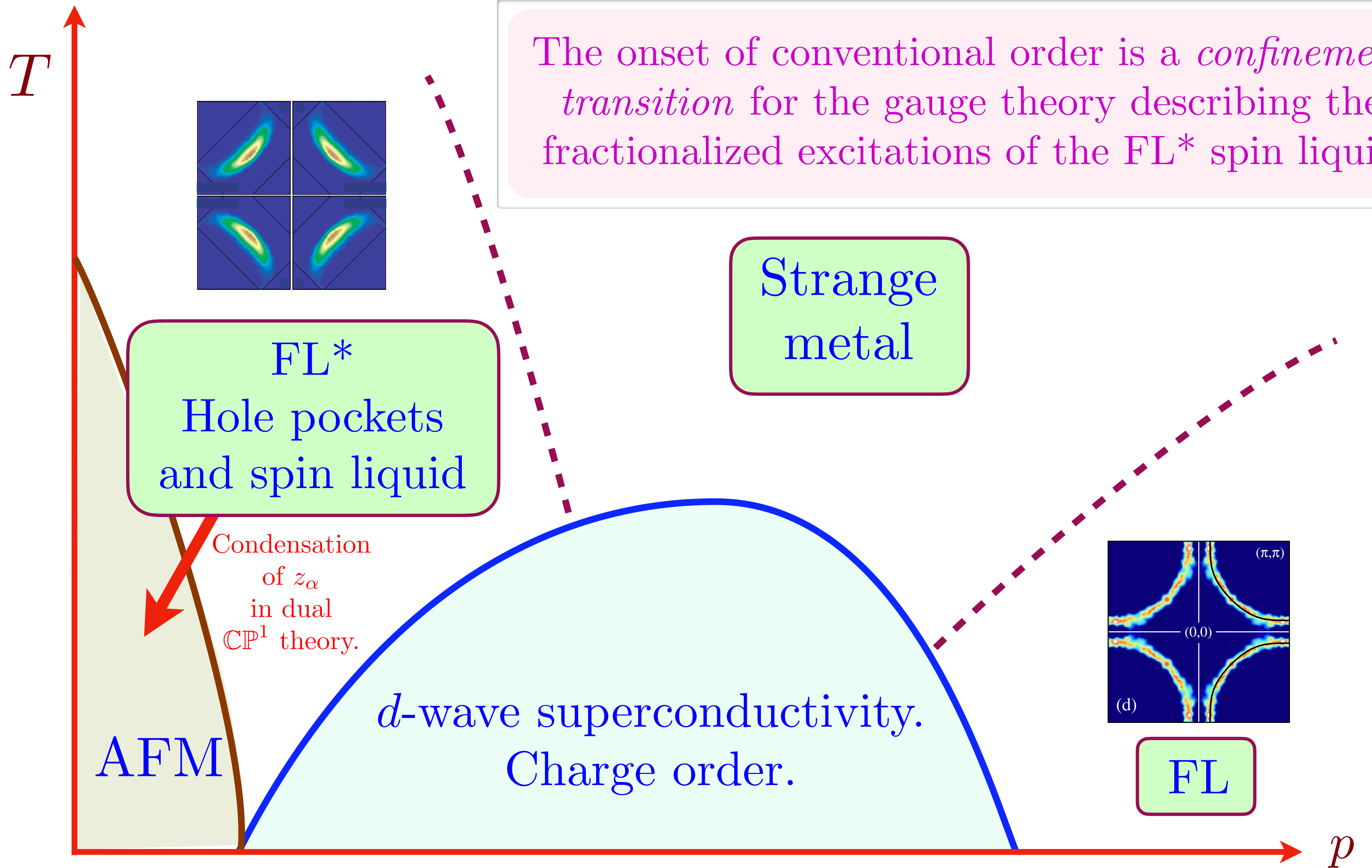

The onset of conventional order is a *confinement transition* for the gauge theory describing the fractionalized excitations of the FL* spin liquid

Strange metal

FL*
Hole pockets and spin liquid

FL

d -wave superconductivity.
Charge order.

AFM

Condensation of z_α in dual CP^1 theory.

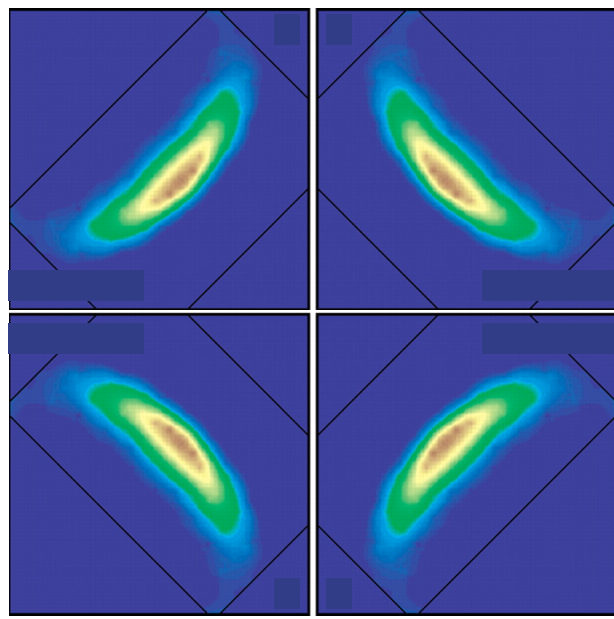
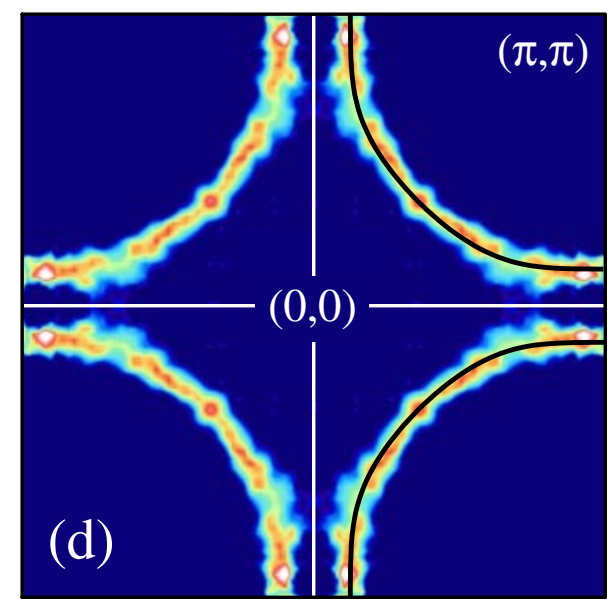

Observable by neutron scattering in pseudogap ?

QMC

Free fermion
spinons in π -flux

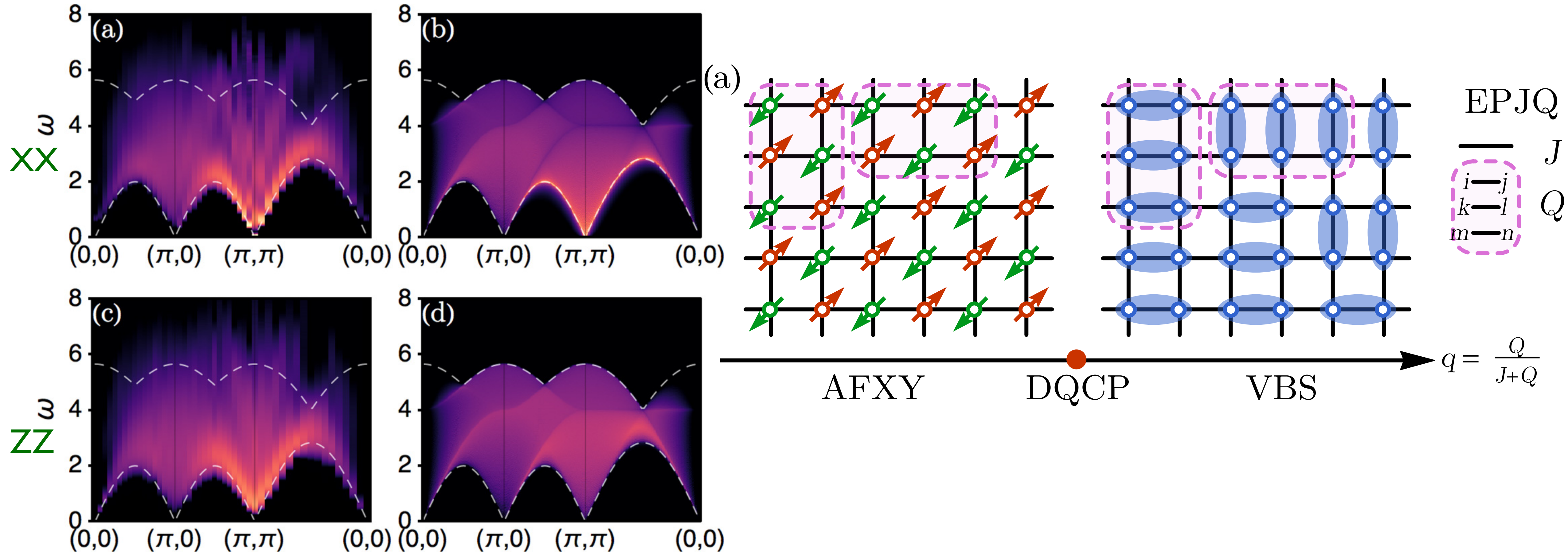

Ultracold fermionic atoms in optical lattices

Microscopic evolution of doped Mott insulators from polaronic metal to Fermi liquid

Joannis Koepsell, Dominik Bourgund, Pimonpan Sompet, Sarah Hirthe, Annabelle Bohrdt, Yao Wang, Fabian Grusdt, Eugene Demler, Guillaume Salomon, Christian Gross, Immanuel Bloch

Science **374** (2021) 82

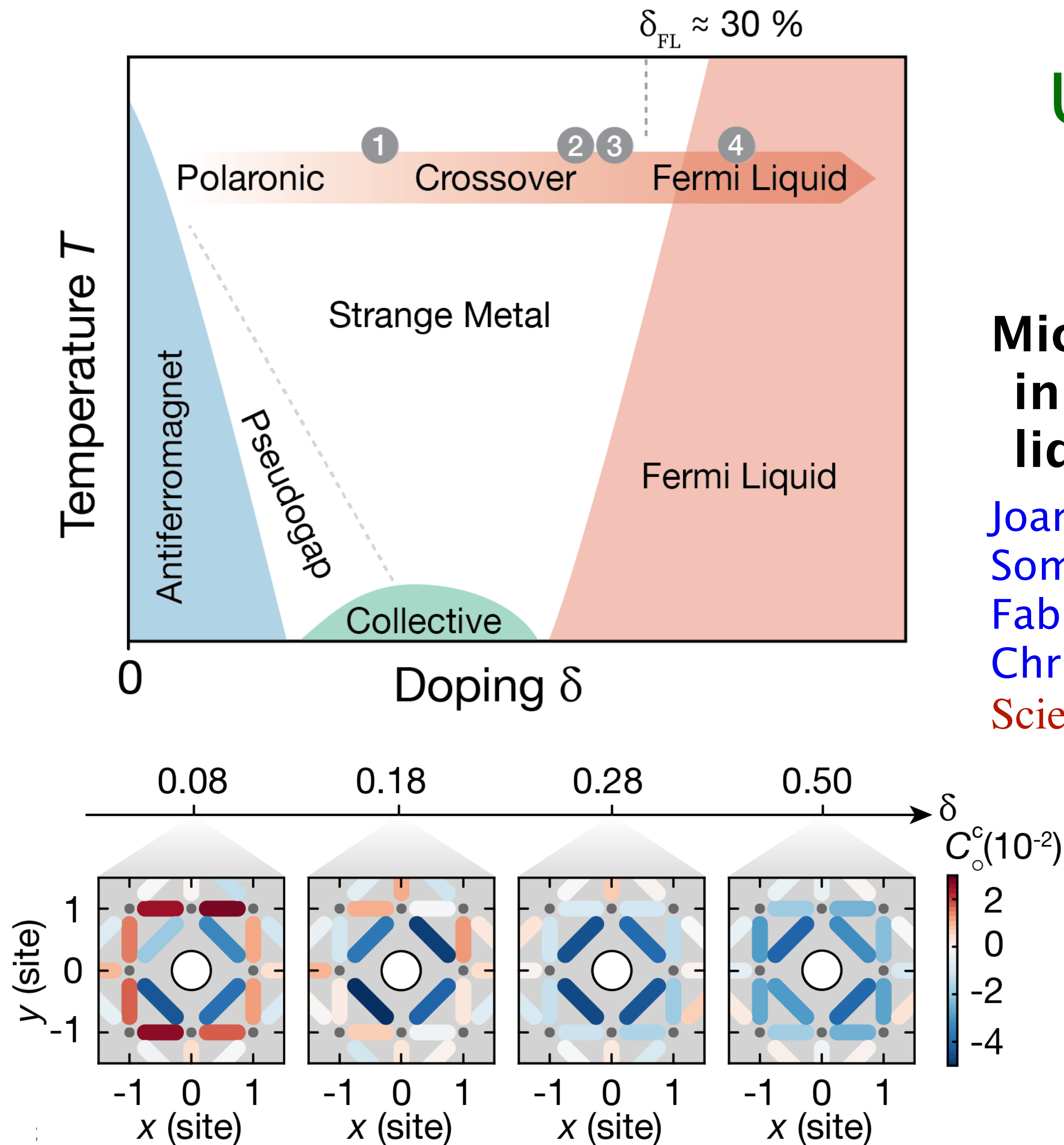

Results for Connected Correlators: Comparison with experiment

Bare Spin-Spin Correlators

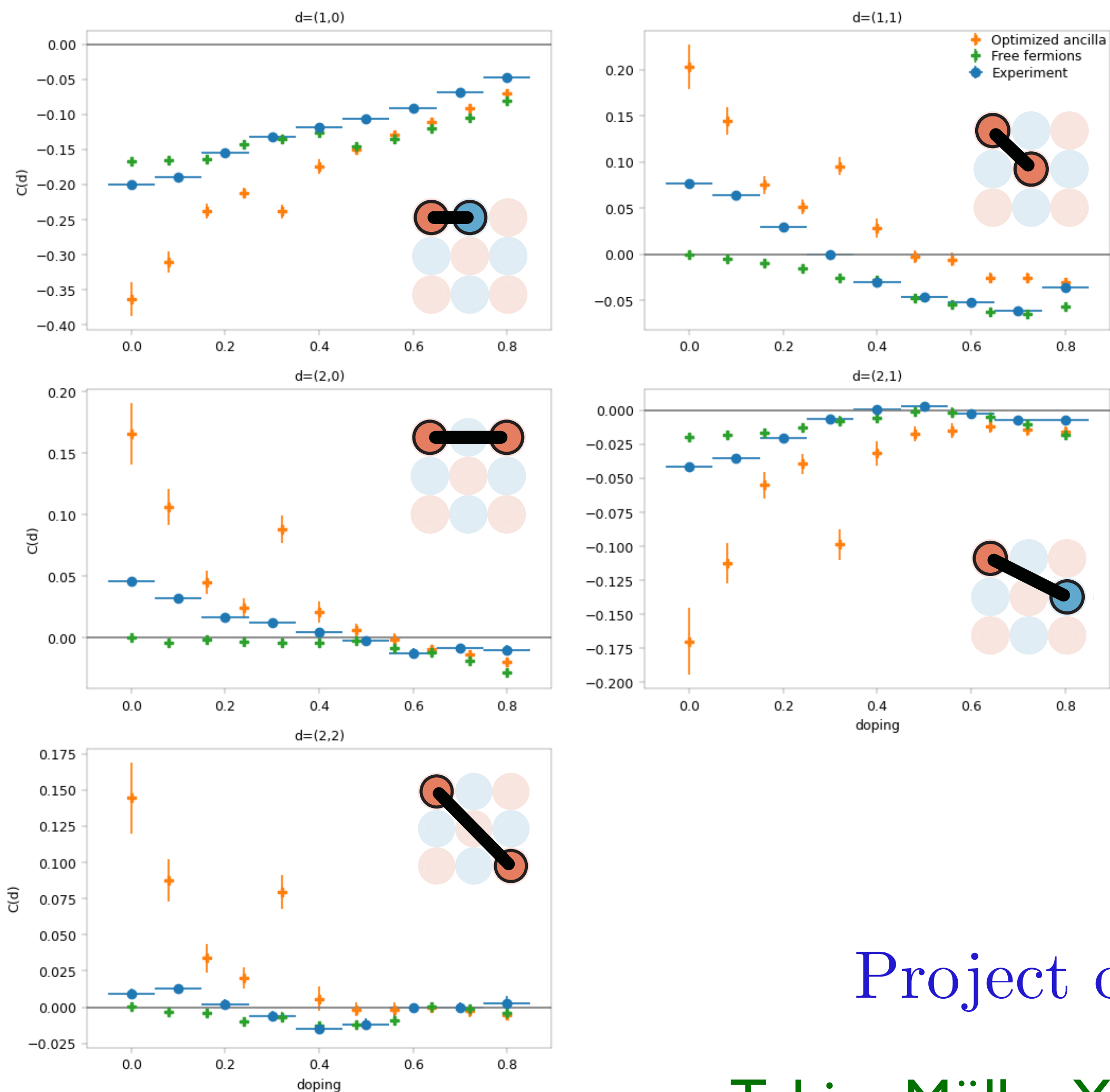

Hole-induced Spin-Spin Correlators

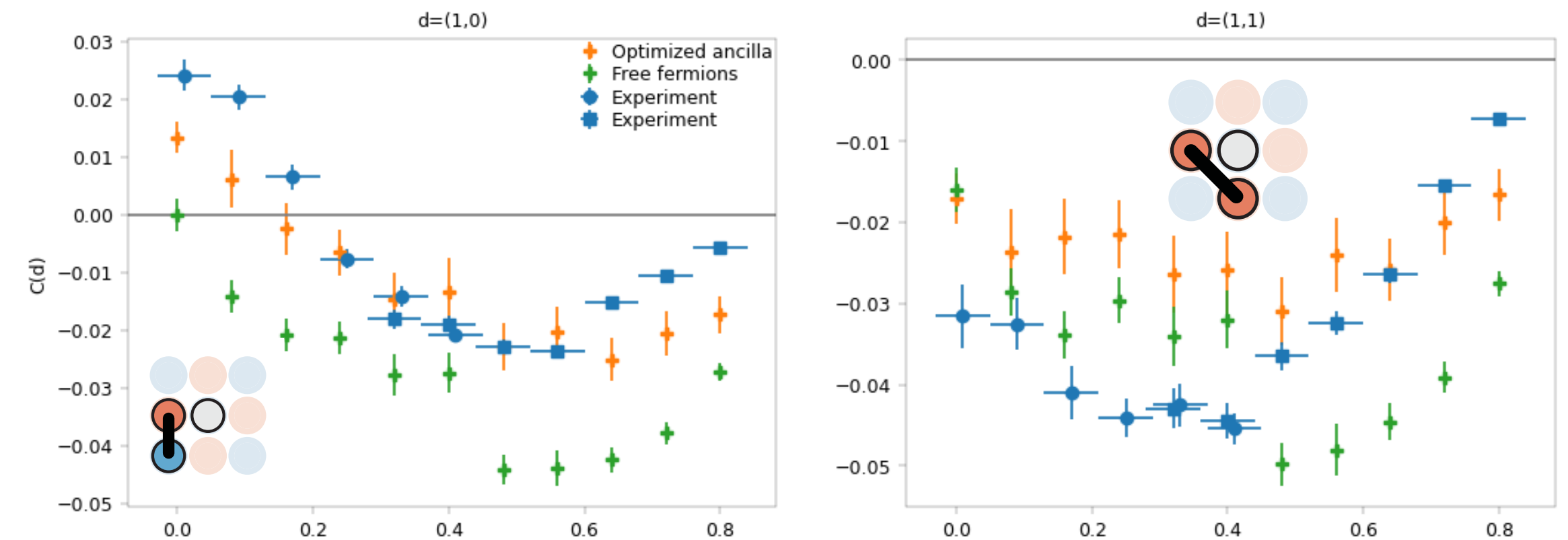

Preliminary data

- *Test different spin-liquid ansätze for second ancilla layer
- *Improve sampling of wave-functions
- *Better statistics to obtain more reliable error-bars

Project only to $S_{1z} + S_{2z} = 0$

Tobias Müller, Yasir Iqbal, Ronny Thomale to appear



Ancilla theory of the Hubbard model

Hole-induced correlations

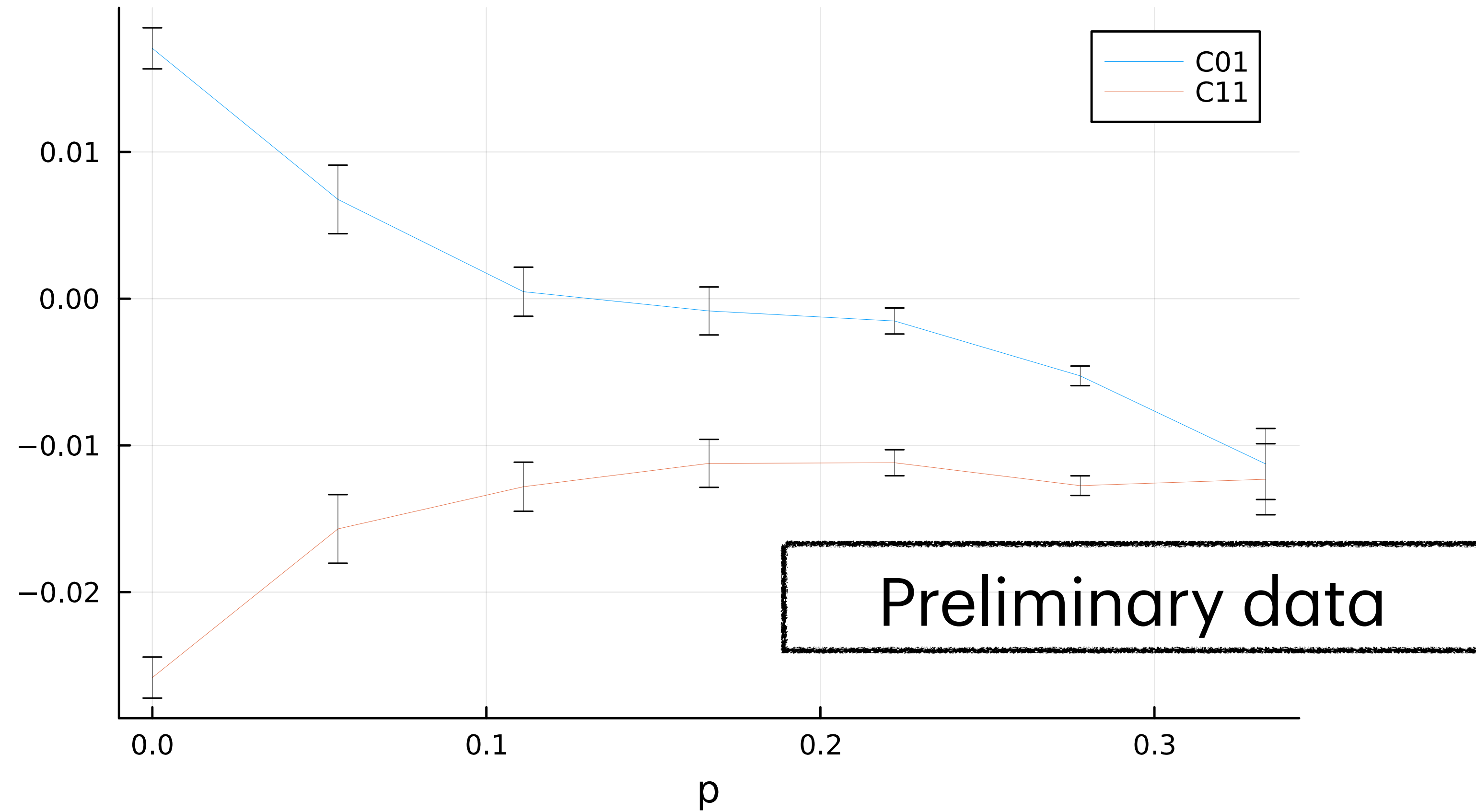

Project to $\mathcal{S}_1 + \mathcal{S}_2 = 0$

H. Shackleton, S.S., Shiwei Zhang, to appear



Summary

Ancilla theory of pseudogap metal with hole pockets and underlying π -flux spin liquid yields:

- Theory for Fermi arcs in hole-doped pseudogap metal.
- **ADMR in pseudogap.**
- Anti-nodal and nodal electronic dispersion.
- ***d*-wave superconductor with 4 nodal points in both electron- and hole-doped cuprates.**
- Near-equality of dSC and charge order onset temperatures
- **Multipoint correlators measured by cold atom experiments**
- Theory for strange metal in the crossover from FL* to FL